

CONTENTS

SECTION A1...STANDARD DOORS / FRAMES⁽¹⁾

	PAGE
STANDARD LOCKING DOORS/FRAMES	
OFFSET PIVOT	A1/4 – 5
BUTT HINGE	A1/6 – 7
CONTINUOUS GEARED HINGE	A1/8 – 9
CENTER PIVOT (END LOAD)	A1/10 – 11
CENTER PIVOT (SIDE LOAD)	A1/12 – 13
CONCEALED ROD EXIT DEVICE DOORS/FRAMES	
OFFSET PIVOT	A1/14 – 15
BUTT HINGE	A1/16 – 17
CONTINUOUS GEARED HINGE	A1/18 – 19
KAWNEER PANELINE® EXIT DEVICE DOORS/FRAMES	
OFFSET PIVOT	A1/20 – 21
BUTT HINGE	A1/22 – 23
CONTINUOUS GEARED HINGE	A1/24 – 25
RIM EXIT DEVICE DOORS/FRAMES	
OFFSET PIVOT	A1/26 – 27
BUTT HINGE	A1/28 – 29
CONTINUOUS GEARED HINGE	A1/30 – 31
STANDARD DOOR MODIFICATIONS	
PUSH/PULL SUBSTITUTIONS	A1/32

¹ STANDARD DOORS / FRAMES ARE NOT A TRUE REPRESENTATION OF WHAT IS "STOCKED." PLEASE CONSULT YOUR LOCAL SERVICE CENTER OR MANUFACTURING FACILITY FOR ACTUAL "STOCK" AVAILABILITY.

* Note: For hardware not listed in the price catalog, consult estimating!

Note: Kawneer entrances in this price book are outswing in recognition of building code life safety considerations.

Laws and building and safety codes governing the design and use of Kawneer products, such as glazed entrance, window, and curtain wall products, vary widely. Kawneer does not control the selection of product configurations, operating hardware, or glazing materials, and assumes no responsibility therefor.

Kawneer reserves the right to change configuration without prior notice when deemed necessary for product improvement.
© 2014, Kawneer Company, Inc.

PART NUMBER STRUCTURE

190 / 350 / 500 DOOR

PRODUCT CODE	+	HANDING	+	PIVOTING	+	LOCKING	+	DOW SIZE
190 = 190 NARROW		R = RIGHT		OP = OFFSET PIVOT		MS = AR1850 MS		36
350 = 350 MEDIUM		L = LEFT		BH = BUTT HUNG		CR = CONCEALED ROD		42
500 = 500 WIDE		P = PAIR		CGH = CONTINUOUS GEARED HINGE		RM = RIM EXIT		72
				CE = CENTER PIVOT END LOAD		PNL = PANELINE®		
				CS = CENTER PIVOT SIDE LOAD				

STANDARD DOOR FRAMES

Trifab® VersaGlaze® is a registered trademark of The Kawneer Company, Inc.

PRODUCT CODE	+	HANDING	+	PIVOTING	+	LOCKING	+	DOW SIZE	+	TRANSOM SUFFIX
400 = TRIFAB® 400		R = RIGHT		OP = OFFSET PIVOT		MS = AR1850 MS		36		TR = WITH TRANSOM
450 = TRIFAB® VG 450*		L = LEFT		BH = BUTT HUNG		CR = CONCEALED ROD		42		
451 = TRIFAB® VG 451*		P = PAIR		CGH = CONTINUOUS GEARED HINGE		RM = RIM EXIT		72		
540 = TRIFAB® 400 OPEN-BACK		S = SINGLE		CE = CENTER PIVOT END LOAD						
550 = TRIFAB® VG 450* OPEN-BACK										
551 = TRIFAB® VG 451 OPEN-BACK										

*NOTE: All Trifab® VersaGlaze® frames are for Center Glaze frames only. "Open-Back" frames do not include side-lite pockets filler.

FINISH GROUPS	
GROUP NO. DESIGNATION	FINISHES INCLUDED
#17 GRP	#17 CLEAR
#40 GRP	#40 BRONZE #22 STD. PAINT #14 CLEAR
#29 GRP	#29 BLACK

NOTICE!

It is responsibility of the owner, the architect, and the installer to make these selections in strict conformity to all applicable laws and building codes.

Laws and building and safety codes governing the design and use of Kawneer products, such as glazed entrance, window, and curtain wall products, vary widely. Kawneer does not control the selection of product configurations, operating hardware, or glazing materials, and assumes no responsibility therefor.

Kawneer reserves the right to change configuration without prior notice when deemed necessary for product improvement.
© 2014, Kawneer Company, Inc.

STANDARD HEIGHT DOORS INCLUDE: FROM 6'8" UP TO 7'0".

SIZING LIMITATIONS (FOR EQUAL LEAVES ONLY - FOR UNEQUAL LEAVES REFER TO A2)

DOOR SIZES MAXIMUM 4'0" X 8'0" SINGLE DOOR; MAXIMUM 8'0" X 8'0" PAIR OF DOORS. (DOOR OPENING SIZE).

FRAME SIZES

WIDTH MAXIMUM 4'0" SINGLE LEAF, DOOR OPENING WIDTH; MAXIMUM 8'0" PAIR OF DOORS, DOOR OPENING WIDTH.
HEIGHT MAXIMUM 8'0" DOOR OPENING HEIGHT ON FRAME WITHOUT TRANSOMS; MAXIMUM 12' ON FRAMES WITH TRANSOMS.

SPECIAL SIZE CHARGE RULES (FOR EQUAL LEAVES ONLY - FOR UNEQUAL LEAVES REFER TO A2)

DOOR SPECIAL WIDTH CHARGE 138234A1 OR 138234CP2 IS TO BE APPLIED **PER LEAF** TO THE CORRELATING 3'0", 3'6" OR 6'0" DOOR PACKAGE BASED ON THE FOLLOWING RULES.

- ANY SINGLE LEAF DOOR THAT DOES NOT HAVE A 3'0" OR 3'6" DOOR OPENING WIDTH.
EXAMPLE 1: A 3'8" DOOR WOULD APPLY (1) 138234CP2 CHARGE TO DOOR PACKAGE 190ROPMS42 (NOTE: THIS WILL SUB A CO-9/CP-II BAR PUSH/PULL SET).
EXAMPLE 2: A 3'8" DOOR WOULD APPLY (1)138234A 1 CHARGE TO DOOR PACKAGE 190ROPMS42 (NOTE: THIS WILL KEEP A CO-9/CP BAR PUSH/PULL SET).
- ANY PAIR OF DOORS THAT DOES NOT HAVE A 6'0" DOOR OPENING WIDTH.
EXAMPLE 1: A 5'10" PAIR OF DOORS WOULD APPLY (2) 138234CP2 CHARGES TO DOOR PACKAGE 190POPMS72 (NOTE: THIS WILL SUB A CO-9/CP-II BAR PUSH/PULL SET).
EXAMPLE 2: A 5'10" PAIR OF DOORS WOULD APPLY (2) 138234A1 CHARGES TO DOOR PACKAGE 190POPMS72 (NOTE: THIS WILL KEEP A CO-9/CP BAR PUSH/PULL SET).

DOOR SPECIAL HEIGHT CHARGE 138233A1 IS TO BE APPLIED **PER LEAF** TO THE CORRELATING 3'0", 3'6" OR 6'0" DOOR PACKAGE BASED ON THE FOLLOWING RULES. (DOORS HAVE STANDARD 11/16" BOTTOM CLEARANCE).

- ANY DOOR THAT DOES NOT HAVE A 6'8" UP TO 7'0" DOOR OPENING HEIGHT.
NOTE: SINGLE DOORS USE (1)138233A1 CHARGE AND PAIRS OF DOORS USE (2)138233A1 CHARGES.

FRAME SPECIAL WIDTH CHARGE 138060 IS TO BE APPLIED **PER FRAME** BASED ON THE FOLLOWING RULES.

- ANY FRAME FOR A SINGLE LEAF DOOR THAT DOES NOT HAVE A 3'0" OR 3'6" DOOR OPENING WIDTH.
- ANY FRAME FOR A PAIR OF DOORS THAT DOES NOT HAVE A 6'0" DOOR OPENING WIDTH.
USE ONLY (1)138060 CHARGE REGARDLESS OF SINGLE OR PAIR TYPE OF FRAME.

FRAME SPECIAL HEIGHT CHARGE 138059 IS TO BE APPLIED **PER FRAME** BASED ON THE FOLLOWING RULES.

- ANY FRAME THAT DOES NOT HAVE A 6'8" UP TO 7'0" DOOR OPENING HEIGHT, OR ANY FRAME WITH A TRANSOM THAT DOES NOT HAVE AN OVERALL FRAME HEIGHT OF UP TO 10' 3-1/2".
USE ONLY (1)138059 CHARGE REGARDLESS OF SINGLE OR PAIR TYPE OF FRAME.

TRANSOM FRAME SPECIAL HEIGHT CHARGE 138099 IS TO BE APPLIED **PER FRAME** BASED ON THE FOLLOWING RULES.

- ANY FRAME WITH A TRANSOM THAT HAS AN OVERALL FRAME HEIGHT BETWEEN 10' 3-1/2" TO 12'.
- TRANSOM HEIGHT NOT TO EXCEED 48", DOOR HEIGHT TO BE ADJUSTED ACCORDINGLY.
USE ONLY (1)138099 CHARGE REGARDLESS OF SINGLE OR PAIR TYPE OF FRAME.

KAWNEER A1 PRICING APPLIES ONLY TO "STANDARD OUTSWING" AND "LEFT HAND OUTSWING ACTIVE LEAF ON PAIRS". ANY CHANGES IN HANDING OR SWING ACTION WILL CAUSE PRICING TO CHANGE TO A2 SECTION OF THE PRICE BOOK.

HARDWARE LIMITATIONS

CLOSER SELECTION LIMITED TO SECTION A3 OPTIONS.

S/A OFFSET ARM CLOSER MAXIMUM DOOR OPENING WIDTH = 3'6".

FLUSH BOLTS: SOME BUILDING CODES, WITH SOME QUALIFICATIONS, PROHIBIT THE USE OF MANUAL FLUSHBOLTS ON EXIT DOORS NEEDED TO HANDLE THE OCCUPANT LOAD OF THE BUILDING. CONSULT WITH YOUR LOCAL CODE TO VERIFY THE USE OF MANUAL FLUSH BOLTS FOR YOUR SPECIFIC APPLICATION.

RULE OF THUMB FOR ADDING INTERMEDIATE HINGES		
DOOR HEIGHT	INFILL WEIGHT	INTERMEDIATES
ALL DOORS	GREATER THAN 5 LB. PER SQ. FT.	ADD ONE (1) HINGE
OVER 7'3"	GREATER THAN 5 LB. PER SQ. FT.	ADD TWO (2) HINGES
OVER 7'6"	LESS THAN 5 LB. PER SQ. FT.	ADD ONE (1) HINGE

RULE OF THUMB FOR ADDING INTERMEDIATE PIVOTS		
DOOR HEIGHT	INFILL WEIGHT	INTERMEDIATES
OVER 7'6"	ALL INFILLS	ADD ONE (1) PIVOT



Laws and building and safety codes governing the design and use of Kawneer products, such as glazed entrance, window, and curtain wall products, vary widely. Kawneer does not control the selection of product configurations, operating hardware, or glazing materials, and assumes no responsibility therefor.

Kawneer reserves the right to change configuration without prior notice when deemed necessary for product improvement.
© 2014, Kawneer Company, Inc.

PRICE INCLUDES:

- 190 NARROW STILE DOOR WITH TOP AND BOTTOM OFFSET PIVOTS AND 1/4" BEVELED GLASS STOPS.
- DOOR INCLUDES ADAMS RITE MS 1850 DEADBOLT LOCK, CYLINDER EXTERIOR, THUMBTURN INTERIOR, FLUSH BOLTS ON PAIRS.
- DOOR INCLUDES CO-9 PULL WITH CP PUSH IN STANDARD #14, #29 OR #40 FINISH (FOR PUSH/PULL SUBSTITUTIONS REFER TO PAGE A1/32).

NOTE: ALL CLOSERS SOLD SEPARATELY. SELECT CLOSER FROM SECTION A3.

DOOR ONLY		
SYSTEM + TYPE = PACKAGE I.E. 190-XXX + ROPMS36 = 190ROPMS36		
		

DOOR OPENING	SINGLE 3'0" x 7'0"	SINGLE 3'6" x 7'0"	PAIR 6'0" x 7'0"
OFFSET PIVOTS			
PART NO.	ROPMS36 LOPMS36	ROPMS42 LOPMS42	POPMS72
#17 GRP.	\$510.00	\$610.00	\$1,020.00
#40 GRP.	536.00	636.00	1,072.00
#29 GRP.	598.00	698.00	1,196.00

DOOR HARDWARE OPTIONS (ALL PRICES ARE EACH)		
138210A1	ADD KAWNEER INTERMEDIATE OFFSET PIVOT	\$175.00
138415A1	ADD RIXSON M-19 INTERMEDIATE OFFSET PIVOT	325.00
138035	OFFSET PIVOT PAINT CHARGE	140.00
138064	SUB S/A OFFSET ARM CONVERSION ⁽¹⁾ (MAXIMUM 3'6" DOOR OPENING)	160.00
138222A1	ACCESSORIES	80.00
138224A1		ADD INTERIOR EXIT INDICATOR
138209		ADD CYLINDER GUARD
		SUB CYLINDER (INTERIOR)
		NO CHARGE
138509	SUB DUMMY CYLINDER	NO CHARGE
138520	SUB CONTROLLER ON PAIRS	(DOOR) 381.00
138522	SUB 3-PT LOCK ON PAIRS	(DOOR) 225.00
138500	SUB MS 1850 SHORT THROW DEADBOLT	(SINGLE DOOR) NO CHARGE
138502	SUB MS 1850 SHORT THROW DEADBOLT	(PAIR DOOR) NO CHARGE
138503	SUB MS 1850 HOOK BOLT	(SINGLE DOOR) 13.00
138505	SUB MS 1850 HOOK BOLT	(PAIR DOOR) 13.00
138506	ADD ADAMS RITE 4015 TWO POINT LOCK BOLT	150.00
138524	SUB ADAMS RITE 4510 LOCK ⁽²⁾	(SINGLE DOOR) 275.00
138526		(PAIR DOOR) 285.00
138527	SUB VESTIBULE CONVERSION ⁽³⁾	(SINGLE DOOR) DEDUCT (59.00)
138529		(PAIR DOOR) DEDUCT (118.00)

DOOR OPTIONS (ALL PRICES ARE PER LEAF UNLESS OTHERWISE NOTED)		
350-XXX	SUB 350 MEDIUM STILE DOOR (CHANGE PREFIX TO 350)	200.00
500-XXX	SUB 500 WIDE STILE DOOR (CHANGE PREFIX TO 500)	375.00
138233A1	SPECIAL HEIGHT DOOR (MAX = 8'0") ⁽⁴⁾	175.00
138234CP2	SPECIAL WIDTH DOOR (MAX = 4'0") ⁽⁴⁾ (SUBS CP-II PUSH)	345.00
138234A1	SPECIAL WIDTH DOOR (MAX = 4'0") ⁽⁴⁾ (USES CP PUSH)	190.00
138214A1	SUB 1/4" SQUARE GLASS STOP	NO CHARGE
138215A1	SUB 3/8" SQUARE GLASS STOP	NO CHARGE
138216A1	SUB 1/2" SQUARE GLASS STOP	NO CHARGE
138217A1	SUB 5/8" SQUARE GLASS STOP	NO CHARGE
138218A1	SUB 3/4" SQUARE GLASS STOP	NO CHARGE
138219A1	SUB 1" SQUARE GLASS STOP	NO CHARGE
138725A1	SUB 7-1/2" BOTTOM RAIL	38.00
138727A1	SUB 10" BOTTOM RAIL	75.00
138731A1	SUB 12" BOTTOM RAIL	290.00
200795A1	ADD 3'0" DOOR BOTTOM WEATHERING (SHIP LOOSE)	25.00
200796A1	ADD 3'6" DOOR BOTTOM WEATHERING (SHIP LOOSE)	27.00
200799A1	ADD 4'0" DOOR BOTTOM WEATHERING (SHIP LOOSE)	28.00
200798A1	ADD 6'0" DOOR BOTTOM WEATHERING FOR PAIRS (SHIP LOOSE)	50.00

DOOR CROSS RAIL OPTIONS (ALL PRICES ARE PER RAIL PER LEAF)		
(A MAXIMUM OF UP TO 2 HORIZONTAL RAILS PER LEAF APPLIES TO THE A1 SECTION)		
038854	5/16" MUNTIN	143.00
038528	7/8" CROSS RAIL	157.00
038529	1-3/8" CROSS RAIL	160.00
038855	2-1/4" CROSS RAIL	164.00
038915	3-1/2" CROSS RAIL	174.00
038735	6" CROSS RAIL	192.00
038123	8-1/4" CROSS RAIL	199.00

¹ PRICE DOES NOT INCLUDE CLOSER. ADD CLOSER FROM SECTION A3.

² PRICE INCLUDES A.R. 4510 LATCH LOCK, A.R. 4560 LEVER HANDLE, STRIKE PLATE & (1) CYLINDER. TO SUBSTITUTE A.R. 4565 EMERGENCY THUMB TURN USE PART #138240A1 AT NO CHARGE LIST, OR TO SUB A.R. 4590 LATCH PADDLE USE PART #138241A1 AND ADD \$60.00 LIST. TO ADD A.R. 7130 ELECTRIC STRIKE HARDWARE AND FRAME PREP FOR SINGLE FRAME SUB #138238A1 AND ADD \$464.00 LIST, TO ADD A.R. 7130 ELECTRIC STRIKE HARDWARE ONLY FOR SINGLE FRAME SUB #138242A1 AND ADD \$360.00 LIST, TO ADD A.R. 7130 ELECTRIC STRIKE FRAME PREP ONLY FOR SINGLE FRAME SUB #138243A1 AND ADD \$104.00 LIST, TO ADD A.R. 7130 ELECTRIC STRIKE FOR PAIR DOORS SUB INTERMEDIATE DUTY PART #138244A1 OR CONTINUOUS DUTY PART #138396A1 AND ADD \$500.00 LIST.

³ VESTIBULE DOOR OPTION REMAINS WITH 11/16" DOOR BOTTOM CLEARANCE (PRICE INCLUDES DEDUCT FOR LOCK, CYLINDER AND THUMBTURN, FLUSHBOLTS ON PAIRS, AND THRESHOLD ON FRAMES).

⁴ REFER TO PAGE A1/3 FOR SPECIAL SIZE CHARGE RULES AND LIMITATIONS.

NOTE: THE USE OF DOUBLE BEND PUSH BARS IS SUGGESTED FOR DOORS REQUIRING 1/2" TO 1" INSULATING GLASS AND/OR DOORS WITH INTERMEDIATE CROSS RAILS. ADD APPROPRIATE PUSH/PULL OR PUSH BAR SUBSTITUTION FROM PAGE A1/32.

EC 97912-065

OFFSET PIVOT FRAMES

PRICE INCLUDES:

- TRIFAB® VERSAGLAZE® 450 CENTER FRAME FABRICATED FOR OFFSET PIVOTS AND STANDARD LOCKING HARDWARE (FLUSHBOLTS ON PAIRS).
- FRAMES WITH TRANSOM AREA (10' 3-1/2") INCLUDE TRANSOM BAR WITH STOPS AND GASKETS.
- FRAMES INCLUDE THRESHOLD, STANDARD 4" WIDE.

NOTE: ALL CLOSERS SOLD SEPARATELY, SELECT CLOSER FROM SECTION A3.

FRAME ONLY						
SYSTEM + TYPE = PACKAGE I.E. 450-XXX + ROPMS36 = 450ROPMS36						
DOOR OPENING	SINGLE	SINGLE	SINGLE	SINGLE	PAIR	PAIR
	3'0" x 7'0"	3'0" x 7'0"	3'6" x 7'0"	3'6" x 7'0"	6'0" x 7'0"	6'0" x 7'0"
OFFSET PIVOTS						
PART NO.	450-XXX	ROPMS36 LOPMS36	ROPMS36TR LOPMS36TR	ROPMS42 LOPMS42	ROPMS42TR LOPMS42TR	POPMS72 POPMS72TR
#17 GRP.		\$296.00	\$463.00	\$322.00	\$497.00	\$363.00
#40 GRP.		308.00	475.00	334.00	509.00	375.00
#29 GRP.		336.00	503.00	362.00	537.00	403.00

FRAME HARDWARE OPTIONS (ALL PRICES ARE EACH)

138211A1	ADD KAWNEER INTERMEDIATE OFFSET PIVOT	\$35.00
138065	SUB STD COC S/A OFFSET ARM CONVERSION ⁽¹⁾ (MAXIMUM 3'6" DOOR OPENING)	148.00
138521	SUB CONTROLLER ON PAIRS	NO CHARGE
138523	SUB 3-PT LOCK ON PAIRS	NO CHARGE
138501	SUB MS 1850 SHORT THROW DEADBOLT	NO CHARGE
138504	SUB MS 1850 HOOK BOLT	NO CHARGE
138525	SUB ADAMS RITE 4510 LOCK ⁽²⁾	(SINGLE FRAME) 23.00
138507	ADD ADAMS RITE 4015 TWO POINT THRESHOLD PREP	(SINGLE FRAME) 30.00
138508		(PAIR FRAME) 30.00
138528	SUB VESTIBULE CONVERSION ⁽³⁾	(SINGLE FRAME) DEDUCT (38.00)
138530		(PAIR FRAME) DEDUCT (43.00)

FRAME SYSTEM OPTIONS (CHANGE PREFIX TO CHANGE FRAME SYSTEM)

400-XXX	SUB TRIFAB® 400 TUBE FRAME WITHOUT TRANSOM	DEDUCT (15.00)
400-XXX	SUB TRIFAB® 400 TUBE FRAME WITH TRANSOM	DEDUCT (50.00)
451-XXX	SUB TRIFAB® VG* 451 TUBE FRAME WITHOUT TRANSOM	10.00
451-XXX	SUB TRIFAB® VG* 451 TUBE FRAME WITH TRANSOM	15.00
540-XXX	SUB TRIFAB® 400 OPEN-BACK WITHOUT TRANSOM	DEDUCT (30.00)
540-XXX	SUB TRIFAB® 400 OPEN-BACK WITH TRANSOM	DEDUCT (80.00)
550-XXX	SUB TRIFAB® VG* 450 OPEN-BACK WITHOUT TRANSOM	DEDUCT (15.00)
550-XXX	SUB TRIFAB® VG* 450 OPEN-BACK WITH TRANSOM	DEDUCT (30.00)
551-XXX	SUB TRIFAB® VG* 451 OPEN-BACK WITHOUT TRANSOM	DEDUCT (5.00)
551-XXX	SUB TRIFAB® VG* 451 OPEN-BACK WITH TRANSOM	DEDUCT (15.00)

***TRIFAB® VERSAGLAZE® FRAMES ARE CENTER GLAZE FRAMES**

FRAME OPTIONS (ALL PRICES ARE EACH)

138059	SPECIAL HEIGHT FRAME ⁽⁴⁾ (LESS THAN 6'8" OR GREATER THAN 7'0" DOOR OPENING HEIGHT WITHOUT TRANSOM; 10' 3-1/2" TRANSOM FRAME WITH DOOR OPENING HEIGHT LESS THAN 6'8" OR GREATER THAN 7'0")	115.00
138060	SPECIAL WIDTH FRAME ⁽⁴⁾ (SINGLE DOOR OPENING WIDTHS OTHER THAN 3'0" OR 3'6" UP TO 4'0"; PAIR DOOR OPENING WIDTHS OTHER THAN 6'0" UP TO 8'0")	115.00
138099	SPECIAL HEIGHT TRANSOM FRAME ⁽⁴⁾ (OVERALL TRANSOM FRAME HEIGHT GREATER THAN 10' 3-1/2" UP TO 12'0" WITH DOOR OPENING HEIGHT FROM 6'8" TO 7'0". TRANSOM HEIGHT MAY NOT EXCEED 48". FOR TRANSOM FRAME WITH DOOR OPENING HEIGHT LESS THAN 6'8" OR GREATER THAN 7'0" ADD PART NUMBER 138059 PER FRAME.)	155.00
138400	DEDUCT TRANSOM HEAD	(SINGLE) DEDUCT (35.00)
138401		(PAIR) DEDUCT (69.00)

¹ PRICE DOES NOT INCLUDE CLOSER. ADD CLOSER FROM SECTION A3.

² TO ADD A.R. 7130 ELECTRIC STRIKE HARDWARE ONLY FOR SINGLE FRAME SUB #138242A1 AND ADD \$360.00 LIST, TO ADD A.R. 7130 ELECTRIC STRIKE FRAME PREP FOR SINGLE FRAME SUB #138243A1 AND ADD \$104.00 LIST, TO ADD A.R. 7130 ELECTRIC STRIKE FOR PAIR DOORS SUB INTERMEDIATE DUTY PART #138244A1 OR CONTINUOUS DUTY PART #138396A1 AND ADD \$500.00 LIST.

³ VESTIBULE DOOR OPTION REMAINS WITH 11/16" DOOR BOTTOM CLEARANCE (PRICE INCLUDES DEDUCT FOR LOCK, CYLINDER AND THUMBTURN, FLUSHBOLTS ON PAIRS, AND THRESHOLD ON FRAMES).

⁴ REFER TO PAGE A1/3 FOR SPECIAL SIZE CHARGE RULES AND LIMITATIONS.

Laws and building and safety codes governing the design and use of Kawneer products, such as glazed entrance, window, and curtain wall products, vary widely. Kawneer does not control the selection of product configurations, operating hardware, or glazing materials, and assumes no responsibility therefor.



Kawneer reserves the right to change configuration without prior notice when deemed necessary for product improvement.

© 2014, Kawneer Company, Inc.

PRICE INCLUDES:

- 190 NARROW STILE DOOR WITH ONE PAIR STANDARD NRP BUTT HINGE AND 1/4" BEVELED GLASS STOPS.
- DOOR INCLUDES ADAMS RITE MS 1850 DEADBOLT LOCK, CYLINDER EXTERIOR, THUMBTURN INTERIOR, FLUSH BOLTS ON PAIRS.
- DOOR INCLUDES CO-9 PULL WITH CP PUSH IN STANDARD #14, #29 OR #40 FINISH (FOR PUSH/PULL SUBSTITUTIONS REFER TO PAGE A1/32).

NOTE: ALL CLOSERS SOLD SEPARATELY. SELECT CLOSER FROM SECTION A3.

DOOR ONLY		
SYSTEM + TYPE = PACKAGE I.E. 190-XXX + RBHMS36 = 190RBHMS36		
		

DOOR OPENING	SINGLE 3'0" x 7'0"	SINGLE 3'6" x 7'0"	PAIR 6'0" x 7'0"
BUTT HINGES			
PART NO.	RBHMS36 LBHMS36	RBHMS42 LBHMS42	PBHMS72
#17 GRP.	\$575.00	\$675.00	\$1,150.00
#40 GRP.	601.00	701.00	1,202.00
#29 GRP.	663.00	763.00	1,326.00

DOOR HARDWARE OPTIONS (ALL PRICES ARE EACH)			
138409A1	ADD KAWNEER 304 STAINLESS STEEL NRP INTERMEDIATE BUTT HINGE		65.00
138064	SUB S/A OFFSET ARM CONVERSION ⁽¹⁾ (MAXIMUM 3'6" DOOR OPENING)		160.00
138222A1	ACCESSORIES	ADD INTERIOR EXIT INDICATOR	80.00
138224A1		ADD CYLINDER GUARD	70.00
138209		SUB CYLINDER (INTERIOR)	NO CHARGE
138509	SUB DUMMY CYLINDER		NO CHARGE
138500	SUB MS 1850 SHORT THROW DEADBOLT	(SINGLE DOOR)	NO CHARGE
138502		(PAIR DOOR)	NO CHARGE
138503	SUB MS 1850 HOOK BOLT	(SINGLE DOOR)	13.00
138505		(PAIR DOOR)	13.00
138506	ADD ADAMS RITE 4015 TWO POINT LOCK BOLT		150.00
138520	SUB CONTROLLER ON PAIRS		381.00
138522	SUB 3-PT LOCK ON PAIRS		225.00
138524	SUB ADAMS RITE 4510 LOCK ⁽²⁾	(SINGLE DOOR)	275.00
138526		(PAIR DOOR)	285.00
138527	SUB VESTIBULE CONVERSION ⁽³⁾	(SINGLE DOOR)	DEDUCT (59.00)
138529		(PAIR DOOR)	DEDUCT (118.00)

DOOR OPTIONS (ALL PRICES ARE PER LEAF UNLESS OTHERWISE NOTED)			
350-XXX	SUB 350 MEDIUM STILE DOOR (CHANGE PREFIX TO 350)		200.00
500-XXX	SUB 500 WIDE STILE DOOR (CHANGE PREFIX TO 500)		375.00
38233A1	SPECIAL HEIGHT DOOR (MAX = 8'0") ⁽⁴⁾		175.00
138234CP2	SPECIAL WIDTH DOOR (MAX = 4'0") ⁽⁴⁾ (SUBS CP-II PUSH)		345.00
138234A1	SPECIAL WIDTH DOOR (MAX = 4'0") ⁽⁴⁾ (USES CP PUSH)		190.00
138214A1	SUB 1/4" SQUARE GLASS STOP		NO CHARGE
138215A1	SUB 3/8" SQUARE GLASS STOP		NO CHARGE
138216A1	SUB 1/2" SQUARE GLASS STOP		NO CHARGE
138217A1	SUB 5/8" SQUARE GLASS STOP		NO CHARGE
138218A1	SUB 3/4" SQUARE GLASS STOP		NO CHARGE
138219A1	SUB 1" SQUARE GLASS STOP		NO CHARGE
138725A1	SUB 7-1/2" BOTTOM RAIL		38.00
138727A1	SUB 10" BOTTOM RAIL		75.00
138731A1	SUB 12" BOTTOM RAIL		290.00
200795A1	ADD 3'0" DOOR BOTTOM WEATHERING (SHIP LOOSE)		25.00
200976A1	ADD 3'6" DOOR BOTTOM WEATHERING (SHIP LOOSE)		27.00
200799A1	ADD 4'0" DOOR BOTTOM WEATHERING (SHIP LOOSE)		28.00
200798A1	ADD 6'0" DOOR BOTTOM WEATHERING FOR PAIRS (SHIP LOOSE)		50.00

DOOR CROSS RAIL OPTIONS (ALL PRICES ARE PER RAIL PER LEAF)			
(A MAXIMUM OF UP TO 2 HORIZONTAL RAILS PER LEAF APPLIES TO THE A1 SECTION)			
038854	5/16" MUNTIN		143.00
038528	7/8" CROSS RAIL		157.00
038529	1-3/8" CROSS RAIL		160.00
038855	2-1/4" CROSS RAIL		164.00
038915	3-1/2" CROSS RAIL		174.00
038735	6" CROSS RAIL		192.00
038123	8-1/4" CROSS RAIL		199.00

¹ PRICE DOES NOT INCLUDE CLOSER. ADD CLOSER FROM SECTION A3.

² PRICE INCLUDES A.R. 4510 LATCH LOCK, A.R. 4560 LEVER HANDLE, STRIKE PLATE & (1) CYLINDER. TO SUBSTITUTE A.R. 4565 EMERGENCY THUMB TURN USE PART #138240A1 AT NO CHARGE LIST, OR TO SUB A.R. 4590 LATCH PADDLE USE PART #138241A1 AND ADD \$60.00 LIST. TO ADD A.R. 7130 ELECTRIC STRIKE HARDWARE AND FRAME PREP FOR SINGLE FRAME SUB #138238A1 AND ADD \$464.00 LIST, TO ADD A.R. 7130 ELECTRIC STRIKE HARDWARE ONLY FOR SINGLE FRAME SUB #138242A1 AND ADD \$360.00 LIST, TO ADD A.R. 7130 ELECTRIC STRIKE FRAME PREP ONLY FOR SINGLE FRAME SUB #138243A1 AND ADD \$104.00 LIST, TO ADD A.R. 7130 ELECTRIC STRIKE FOR PAIR DOORS SUB INTERMEDIATE DUTY PART #138244A1 OR CONTINUOUS DUTY PART #138396A1 AND ADD \$500.00 LIST.

³ VESTIBULE DOOR OPTION REMAINS WITH 11/16" DOOR BOTTOM CLEARANCE (PRICE INCLUDES DEDUCT FOR LOCK, CYLINDER AND THUMBTURN, FLUSHBOLTS ON PAIRS, AND THRESHOLD ON FRAMES).

⁴ REFER TO PAGE A1/3 FOR SPECIAL SIZE CHARGE RULES AND LIMITATIONS.

NOTE: THE USE OF DOUBLE BEND PUSH BARS IS SUGGESTED FOR DOORS REQUIRING 1/2" TO 1" INSULATING GLASS AND/OR DOORS WITH INTERMEDIATE CROSS RAILS. ADD APPROPRIATE PUSH/PULL OR PUSH BAR SUBSTITUTION FROM PAGE A1/32.

Laws and building and safety codes governing the design and use of Kawneer products, such as glazed entrance, window, and curtain wall products, vary widely. Kawneer does not control the selection of product configurations, operating hardware, or glazing materials, and assumes no responsibility therefor.

Kawneer reserves the right to change configuration without prior notice when deemed necessary for product improvement.
© 2014, Kawneer Company, Inc.

EC 97912-065

BUTT HINGE FRAMES

PRICE INCLUDES:

- TRIFAB® VERSAGLAZE® 450 CENTER FRAME FABRICATED FOR BUTT HINGES AND STANDARD LOCKING HARDWARE (FLUSH BOLTS ON PAIRS).
- FRAMES WITH TRANSOM AREA (10' 3-1/2") INCLUDE TRANSOM BAR WITH STOPS AND GASKETS.
- FRAMES INCLUDE THRESHOLD, STANDARD 4" WIDE.

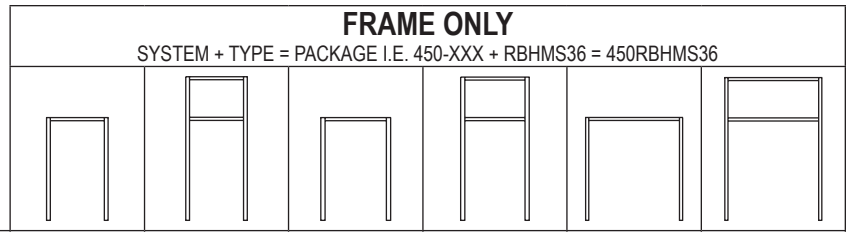

NOTE: ALL CLOSERS SOLD SEPARATELY, SELECT CLOSER FROM SECTION A3.

DOOR OPENING		SINGLE	SINGLE	SINGLE	SINGLE	PAIR	PAIR
		3'0" x 7'0"	3'0" x 7'0"	3'6" x 7'0"	3'6" x 7'0"	6'0" x 7'0"	6'0" x 7'0"
BUTT HINGES							
PART NO.	450-XXX	RBHMS36 LBHMS36	RBHMS36TR LBHMS36TR	RBHMS42 LBHMS42	RBHMS42TR LBHMS42TR	PBHMS72	PBHMS72TR
#17 GRP.		\$323.00	\$494.00	\$350.00	\$528.00	\$414.00	\$675.00
#40 GRP.		336.00	506.00	362.00	540.00	426.00	688.00
#29 GRP.		364.00	535.00	391.00	569.00	454.00	716.00

FRAME HARDWARE OPTIONS (ALL PRICES ARE EACH)

138418A1	ADD KAWNEER INTERMEDIATE BUTT HINGE	\$36.00
138065	SUB STD COC S/A OFFSET ARM CONVERSION ⁽¹⁾ (MAXIMUM 3'6" DOOR OPENING)	148.00
138521	SUB CONTROLLER ON PAIRS	NO CHARGE
138523	SUB 3-PT LOCK ON PAIRS	NO CHARGE
138501	SUB MS 1850 SHORT THROW DEADBOLT	NO CHARGE
138504	SUB MS 1850 HOOK BOLT	NO CHARGE
138525	SUB ADAMS RITE 4510 LOCK ⁽²⁾	(SINGLE FRAME) 23.00
138507	ADD ADAMS RITE 4015 TWO POINT THRESHOLD PREP	(SINGLE FRAME) 30.00
138508		(PAIR FRAME) 30.00
138528	SUB VESTIBULE CONVERSION ⁽³⁾	(SINGLE FRAME) DEDUCT (38.00)
138530		(PAIR FRAME) DEDUCT (43.00)

FRAME SYSTEM OPTIONS (CHANGE PREFIX TO CHANGE FRAME SYSTEM)

400-XXX	SUB TRIFAB® 400 TUBE FRAME WITHOUT TRANSOM	DEDUCT (15.00)
400-XXX	SUB TRIFAB® 400 TUBE FRAME WITH TRANSOM	DEDUCT (50.00)
451-XXX	SUB TRIFAB® VG 451 TUBE FRAME WITHOUT TRANSOM	10.00
451-XXX	SUB TRIFAB® VG 451 TUBE FRAME WITH TRANSOM	15.00
540-XXX	SUB TRIFAB® 400 OPEN-BACK WITHOUT TRANSOM	DEDUCT (30.00)
540-XXX	SUB TRIFAB® 400 OPEN-BACK WITH TRANSOM	DEDUCT (80.00)
550-XXX	SUB TRIFAB® VG* 450 OPEN-BACK WITHOUT TRANSOM	DEDUCT (15.00)
550-XXX	SUB TRIFAB® VG* 450 OPEN-BACK WITH TRANSOM	DEDUCT (30.00)
551-XXX	SUB TRIFAB® VG* 451 OPEN-BACK WITHOUT TRANSOM	DEDUCT (5.00)
551-XXX	SUB TRIFAB® VG* 451 OPEN-BACK WITH TRANSOM	DEDUCT (15.00)

*TRIFAB® VERSAGLAZE® FRAMES ARE CENTER GLAZE FRAMES

FRAME OPTIONS (ALL PRICES ARE EACH)

138059	SPECIAL HEIGHT FRAME ⁽⁴⁾ (LESS THAN 6'8" OR GREATER THAN 7'0" DOOR OPENING HEIGHT WITHOUT TRANSOM; 10' 3-1/2" TRANSOM FRAME WITH DOOR OPENING HEIGHT LESS THAN 6'8" OR GREATER THAN 7'0")	115.00
138060	SPECIAL WIDTH FRAME ⁽⁴⁾ (SINGLE DOOR OPENING WIDTHS OTHER THAN 3'0" OR 3'6" UP TO 4'0"; PAIR DOOR OPENING WIDTHS OTHER THAN 6'0" UP TO 8'0")	115.00
138099	SPECIAL HEIGHT TRANSOM FRAME ⁽⁴⁾ (OVERALL TRANSOM FRAME HEIGHT GREATER THAN 10' 3-1/2" UP TO 12'0" WITH DOOR OPENING HEIGHT FROM 6'8" TO 7'0". TRANSOM HEIGHT MAY NOT EXCEED 48". FOR TRANSOM FRAME WITH DOOR OPENING HEIGHT LESS THAN 6'8" OR GREATER THAN 7'0" ADD PART NUMBER 138059 PER FRAME.)	155.00
138400	DEDUCT TRANSOM HEAD	(SINGLE) DEDUCT (35.00)
138401		(PAIR) DEDUCT (69.00)

¹ PRICE DOES NOT INCLUDE CLOSER. ADD CLOSER FROM SECTION A3.

² TO ADD A.R. 7130 ELECTRIC STRIKE HARDWARE ONLY FOR SINGLE FRAME SUB #138242A1 AND ADD \$360.00 LIST, TO ADD A.R. 7130 ELECTRIC STRIKE FRAME PREP FOR SINGLE FRAME SUB #138243A1 AND ADD \$104.00 LIST, TO ADD A.R. 7130 ELECTRIC STRIKE FOR PAIR DOORS SUB INTERMEDIATE DUTY PART #138244A1 OR CONTINUOUS DUTY PART #138396A1 AND ADD \$500.00 LIST.

³ VESTIBULE DOOR OPTION REMAINS WITH 11/16" DOOR BOTTOM CLEARANCE (PRICE INCLUDES DEDUCT FOR LOCK, CYLINDER AND THUMBTURN, FLUSH BOLTS ON PAIRS, AND THRESHOLD ON FRAMES).

⁴ REFER TO PAGE A1/3 FOR SPECIAL SIZE CHARGE RULES AND LIMITATIONS.



Laws and building and safety codes governing the design and use of Kawneer products, such as glazed entrance, window, and curtain wall products, vary widely. Kawneer does not control the selection of product configurations, operating hardware, or glazing materials, and assumes no responsibility therefor.

Kawneer reserves the right to change configuration without prior notice when deemed necessary for product improvement.
© 2014, Kawneer Company, Inc.

PRICE INCLUDES:

- 190 NARROW STILE DOOR WITH CONTINUOUS GEARED HINGE AND 1/4" BEVELED GLASS STOPS.
- DOOR INCLUDES ADAMS RITE MS 1850 DEADBOLT LOCK, CYLINDER EXTERIOR, THUMBTURN INTERIOR, FLUSH BOLTS ON PAIRS.
- DOOR INCLUDES CO-9 PULL WITH CP PUSH IN STANDARD #14, #29 OR #40 FINISH (FOR PUSH/PULL SUBSTITUTIONS REFER TO PAGE A1/32).

NOTE: ALL CLOSERS SOLD SEPARATELY. SELECT CLOSER FROM SECTION A3.

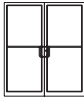
DOOR ONLY		
SYSTEM + TYPE = PACKAGE		
I.E. 190-XXX + RCGHMS36 = 190RCGHMS36		
		

DOOR OPENING	SINGLE	SINGLE	PAIR	
	3'0" x 7'0"	3'6" x 7'0"	6'0" x 7'0"	
CONTINUOUS GEARED HINGE				
PART NO.	190-XXX	RCGHMS36 LCGHMS36	RCGHMS42 LCGHMS42	PCGHMS72
#17 GRP.		\$823.00	\$923.00	\$1,646.00
#40 GRP.		849.00	949.00	1,698.00
#29 GRP.		911.00	1,011.00	1,822.00

DOOR HARDWARE OPTIONS (ALL PRICES ARE EACH)			
138064	SUB S/A OFFSET ARM CONVERSION ⁽¹⁾ (MAXIMUM 3'6" DOOR OPENING)		\$160.00
138222A1	ACCESSORIES	ADD INTERIOR EXIT INDICATOR	80.00
138224A1		ADD CYLINDER GUARD	70.00
138209		SUB CYLINDER (INTERIOR)	NO CHARGE
138509	SUB DUMMY CYLINDER		NO CHARGE
138520	SUB CONTROLLER ON PAIRS		381.00
138522	SUB 3-PT LOCK ON PAIRS		225.00
138500	SUB MS 1850 SHORT THROW DEADBOLT	(SINGLE DOOR)	NO CHARGE
138502		(PAIR DOOR)	NO CHARGE
138503	SUB MS 1850 HOOK BOLT	(SINGLE DOOR)	13.00
138505		(PAIR DOOR)	13.00
135506	ADD ADAMS RITE 4015 TWO POINT LOCK BOLT		150.00
138524	SUB ADAMS RITE 4510 LOCK ⁽²⁾	(SINGLE DOOR)	275.00
138526		(PAIR DOOR)	285.00
138527	SUB VESTIBULE CONVERSION ⁽³⁾	(SINGLE DOOR)	DEDUCT (59.00)
138529		(PAIR DOOR)	DEDUCT (118.00)

DOOR OPTIONS (ALL PRICES ARE PER LEAF UNLESS OTHERWISE NOTED)			
350-XXX	SUB 350 MEDIUM STILE DOOR (CHANGE PREFIX TO 350)		200.00
500-XXX	SUB 500 WIDE STILE DOOR (CHANGE PREFIX TO 500)		375.00
138233A1	SPECIAL HEIGHT DOOR (MAX = 8'0") ⁽⁴⁾		175.00
138234CP2	SPECIAL WIDTH DOOR (MAX = 4'0") ⁽⁴⁾ (SUB CP-II PUSH)		345.00
138234A1	SPECIAL WIDTH DOOR (MAX = 4'0") ⁽⁴⁾ (USES CP PUSH)		190.00
138214A1	SUB 1/4" SQUARE GLASS STOP		NO CHARGE
138215A1	SUB 3/8" SQUARE GLASS STOP		NO CHARGE
138216A1	SUB 1/2" SQUARE GLASS STOP		NO CHARGE
138217A1	SUB 5/8" SQUARE GLASS STOP		NO CHARGE
138218A1	SUB 3/4" SQUARE GLASS STOP		NO CHARGE
138219A1	SUB 1" SQUARE GLASS STOP		NO CHARGE
138725A1	SUB 7-1/2" BOTTOM RAIL		38.00
138727A1	SUB 10" BOTTOM RAIL		75.00
138731A1	SUB 12" BOTTOM RAIL		290.00
200795A1	ADD 3'0" DOOR BOTTOM WEATHERING (SHIP LOOSE)		25.00
200796A1	ADD 3'6" DOOR BOTTOM WEATHERING (SHIP LOOSE)		27.00
200799A1	ADD 4'0" DOOR BOTTOM WEATHERING (SHIP LOOSE)		28.00
200798A1	ADD 6'0" DOOR BOTTOM WEATHERING FOR PAIRS (SHIP LOOSE)		50.00

DOOR CROSS RAIL OPTIONS (ALL PRICES ARE PER RAIL PER LEAF)			
(A MAXIMUM OF UP TO 2 HORIZONTAL RAILS PER LEAF APPLIES TO THE A1 SECTION)			
038854	5/16" MUNTIN		143.00
038528	7/8" CROSS RAIL		157.00
038529	1-3/8" CROSS RAIL		160.00
038855	2-1/4" CROSS RAIL		164.00
038915	3-1/2" CROSS RAIL		174.00
038735	6" CROSS RAIL		192.00
038123	8-1/4" CROSS RAIL		199.00

¹ PRICE DOES NOT INCLUDE CLOSER. ADD CLOSER FROM SECTION A3.

² PRICE INCLUDES A.R. 4510 LATCH LOCK, A.R. 4560 LEVER HANDLE, STRIKE PLATE & (1) CYLINDER. TO SUBSTITUTE A.R. 4565 EMERGENCY THUMB TURN USE PART #138240A1 AT NO CHARGE LIST, OR TO SUB A.R. 4590 LATCH PADDLE USE PART #138241A1 AND ADD \$60.00 LIST. TO ADD A.R. 7130 ELECTRIC STRIKE HARDWARE AND FRAME PREP FOR SINGLE FRAME SUB #138238A1 AND ADD \$464.00 LIST, TO ADD A.R. 7130 ELECTRIC STRIKE HARDWARE ONLY FOR SINGLE FRAME SUB #138242A1 AND ADD \$360.00 LIST, TO ADD A.R. 7130 ELECTRIC STRIKE FRAME PREP ONLY FOR SINGLE FRAME SUB #138243A1 AND ADD \$104.00 LIST, TO ADD A.R. 7130 ELECTRIC STRIKE FOR PAIR DOORS SUB INTERMEDIATE DUTY PART #138244A1 OR CONTINUOUS DUTY PART #138396A1 AND ADD \$500.00 LIST.

³ VESTIBULE DOOR OPTION REMAINS WITH 11/16" DOOR BOTTOM CLEARANCE (PRICE INCLUDES DEDUCT FOR LOCK, CYLINDER AND THUMBTURN, FLUSHBOLTS ON PAIRS, AND THRESHOLD ON FRAMES).

⁴ REFER TO PAGE A1/3 FOR SPECIAL SIZE CHARGE RULES AND LIMITATIONS.

NOTE: THE USE OF DOUBLE BEND PUSH BARS IS SUGGESTED FOR DOORS REQUIRING 1/2" TO 1" INSULATING GLASS AND/OR DOORS WITH INTERMEDIATE CROSS RAILS. ADD APPROPRIATE PUSH/PULL OR PUSH BAR SUBSTITUTION FROM PAGE A1/32.

EC 97912-065

CONTINUOUS GEARED HINGE FRAMES

PRICE INCLUDES:

1. TRIFAB® VERSAGLAZE® 450 CENTER FRAME FABRICATED FOR CONTINUOUS GEARED HINGES AND STANDARD LOCKING HARDWARE (FLUSHBOLTS ON PAIRS).
2. FRAMES WITH TRANSOM AREA (10' 3-1/2" INCLUDE TRANSOM BAR WITH STOPS AND GASKETS).
3. FRAMES INCLUDE THRESHOLD, STANDARD 4" WIDE.

NOTE: ALL CLOSERS SOLD SEPARATELY, SELECT CLOSER FROM SECTION A3.

FRAME ONLY						
SYSTEM + TYPE = PACKAGE I.E. 450-XXX + RCGHMS36 = 450RCGHMS36						
DOOR OPENING	SINGLE	SINGLE	SINGLE	SINGLE	PAIR	PAIR
	3'0" x 7'0"	3'0" x 7'0"	3'6" x 7'0"	3'6" x 7'0"	6'0" x 7'0"	6'0" x 7'0"
CONTINUOUS GEARED HINGE						
PART NO.	RCGHMS36 LCGHMS36	RCGHMS36TR LCGHMS36TR	RCGHMS42 LCGHMS42	RCGHMS42TR LCGHMS42TR	PCGHMS72	PCGHMS72TR
#17 GRP.	\$323.00	\$494.00	\$350.00	\$528.00	\$414.00	\$675.00
#40 GRP.	336.00	506.00	362.00	540.00	426.00	688.00
#29 GRP.	364.00	535.00	391.00	569.00	454.00	716.00

FRAME HARDWARE OPTIONS (ALL PRICES ARE EACH)

138065	SUB STD COC S/A OFFSET ARM CONVERSION ⁽¹⁾ (MAXIMUM 3'6" DOOR OPENING)	\$148.00
138521	SUB CONTROLLER ON PAIRS	NO CHARGE
138523	SUB 3-PT LOCK ON PAIRS	NO CHARGE
138501	SUB MS 1850 SHORT THROW DEADBOLT	NO CHARGE
138504	SUB MS 1850 HOOK BOLT	NO CHARGE
138525	SUB ADAMS RITE 4510 LOCK ⁽²⁾	(SINGLE FRAME) 23.00
138507	ADD ADAMS RITE 4015 TWO POINT THRESHOLD PREP	(SINGLE FRAME) 30.00
138508		(PAIR FRAME) 30.00
138528	SUB VESTIBULE CONVERSION ⁽³⁾	(SINGLE FRAME) DEDUCT (38.00)
138530		(PAIR FRAME) DEDUCT (43.00)

FRAME SYSTEM OPTIONS (CHANGE PREFIX TO CHANGE FRAME SYSTEM)

400-XXX	SUB TRIFAB® 400 TUBE FRAME WITHOUT TRANSOM	DEDUCT (15.00)
400-XXX	SUB TRIFAB® 400 TUBE FRAME WITH TRANSOM	DEDUCT (50.00)
451-XXX	SUB TRIFAB® VG 451 TUBE FRAME WITHOUT TRANSOM	10.00
451-XXX	SUB TRIFAB® VG 451 TUBE FRAME WITH TRANSOM	15.00
540-XXX	SUB TRIFAB® 400 OPEN-BACK WITHOUT TRANSOM	DEDUCT (30.00)
540-XXX	SUB TRIFAB® 400 OPEN-BACK WITH TRANSOM	DEDUCT (80.00)
550-XXX	SUB TRIFAB® VG* 450 OPEN-BACK WITHOUT TRANSOM	DEDUCT (15.00)
550-XXX	SUB TRIFAB® VG* 450 OPEN-BACK WITH TRANSOM	DEDUCT (30.00)
551-XXX	SUB TRIFAB® VG* 451 OPEN-BACK WITHOUT TRANSOM	DEDUCT (5.00)
551-XXX	SUB TRIFAB® VG* 451 OPEN-BACK WITH TRANSOM	DEDUCT (15.00)

*TRIFAB® VERSAGLAZE® FRAMES ARE CENTER GLAZE FRAMES

FRAME OPTIONS (ALL PRICES ARE EACH)

138059	SPECIAL HEIGHT FRAME ⁽⁴⁾ (LESS THAN 6'8" OR GREATER THAN 7'0" DOOR OPENING HEIGHT WITHOUT TRANSOM; 10' 3-1/2" TRANSOM FRAME WITH DOOR OPENING HEIGHT LESS THAN 6'8" OR GREATER THAN 7'0")	115.00
138060	SPECIAL WIDTH FRAME ⁽⁴⁾ (SINGLE DOOR OPENING WIDTHS OTHER THAN 3'0" OR 3'6" UP TO 4'0"; PAIR DOOR OPENING WIDTHS OTHER THAN 6'0" UP TO 8'0")	115.00
138099	SPECIAL HEIGHT TRANSOM FRAME ⁽⁴⁾ (OVERALL TRANSOM FRAME HEIGHT GREATER THAN 10' 3-1/2" UP TO 12'0" WITH DOOR OPENING HEIGHT FROM 6'8" TO 7'0". TRANSOM HEIGHT MAY NOT EXCEED 48". FOR TRANSOM FRAME WITH DOOR OPENING HEIGHT LESS THAN 6'8" OR GREATER THAN 7'0" ADD PART NUMBER 138059 PER FRAME.)	155.00
138400	DEDUCT TRANSOM HEAD	(SINGLE) DEDUCT (35.00)
138401		(PAIR) DEDUCT (69.00)

¹ PRICE DOES NOT INCLUDE CLOSER. ADD CLOSER FROM SECTION A3.

² TO ADD A.R. 7130 ELECTRIC STRIKE HARDWARE ONLY FOR SINGLE FRAME SUB #138242A1 AND ADD \$360.00 LIST, TO ADD A.R. 7130 ELECTRIC STRIKE FRAME PREP FOR SINGLE FRAME SUB #138243A1 AND ADD \$104.00 LIST, TO ADD A.R. 7130 ELECTRIC STRIKE FOR PAIR DOORS SUB INTERMEDIATE DUTY PART #138244A1 OR CONTINUOUS DUTY PART #138396A1 AND ADD \$500.00 LIST.

³ VESTIBULE DOOR OPTION REMAINS WITH 11/16" DOOR BOTTOM CLEARANCE (PRICE INCLUDES DEDUCT FOR LOCK, CYLINDER AND THUMBTURN, FLUSHBOLTS ON PAIRS, AND THRESHOLD ON FRAMES).

⁴ REFER TO PAGE A1/3 FOR SPECIAL SIZE CHARGE RULES AND LIMITATIONS.

Laws and building and safety codes governing the design and use of Kawneer products, such as glazed entrance, window, and curtain wall products, vary widely. Kawneer does not control the selection of product configurations, operating hardware, or glazing materials, and assumes no responsibility therefor.

Kawneer reserves the right to change configuration without prior notice when deemed necessary for product improvement.
© 2014, Kawneer Company, Inc.

PRICE INCLUDES:

- 190 NARROW STILE DOOR PREPPED FOR TOP END LOAD ARM AND WITH BOTTOM CENTER PIVOT AND 1/4" BEVELED GLASS STOPS (**CLOSER AND TOP ARM ARE NOT INCLUDED**).
- DOOR INCLUDES ADAMS RITE MS 1850 DEADBOLT LOCK, CYLINDER EXTERIOR, THUMBTURN INTERIOR, FLUSH BOLTS ON PAIRS.
- DOOR INCLUDES CP PUSH BARS BACK TO BACK IN STANDARD #14, #29 OR #40 FINISH.
(FOR PUSH/PULL SUBSTITUTIONS REFER TO PAGE A1/32).

NOTE: ALL CLOSERS SOLD SEPARATELY. SELECT CLOSER FROM SECTION A3.

DOOR ONLY
SYSTEM + TYPE = PACKAGE
I.E. 190-XXX + RCEMS36 = 190RCEMS36

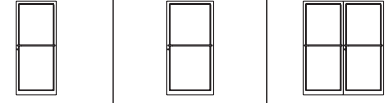

DOOR OPENING	SINGLE 3'0" x 7'0"	SINGLE 3'6" x 7'0"	PAIR 6'0" x 7'0"	
CENTER PIVOTS - END LOAD				
PART NO.	190-XXX	RCEMS36 LCEMS36	RCEMS42 LCEMS42	PCEMS72
#17 GRP.		\$510.00	\$610.00	\$1,020.00
#40 GRP.		536.00	630.00	1,072.00
#29 GRP.		598.00	698.00	1,196.00

DOOR HARDWARE OPTIONS (ALL PRICES ARE EACH)

138069	ADD AND APPLY END LOAD ARM AND CLAMPING BLOCK PACKAGE ⁽¹⁾		\$73.00
138222A1	ACCESSORIES	ADD INTERIOR EXIT INDICATOR	80.00
138224A1		ADD CYLINDER GUARD	70.00
138209		SUB CYLINDER (INTERIOR)	NO CHARGE
138509	SUB DUMMY CYLINDER		NO CHARGE
138520	SUB CONTROLLER ON PAIRS		381.00
138522	SUB 3-PT LOCK ON PAIRS		225.00
138500	SUB MS 1850 SHORT THROW DEADBOLT	(SINGLE DOOR)	NO CHARGE
138502		(PAIR DOOR)	NO CHARGE
138503	SUB MS 1850 HOOK BOLT	(SINGLE DOOR)	13.00
138505		(PAIR DOOR)	13.00
135506	ADD ADAMS RITE 4015 TWO POINT LOCK BOLT		150.00
138524	SUB ADAMS RITE 4510 LOCK ⁽²⁾	(SINGLE DOOR)	275.00
138526		(PAIR DOOR)	285.00
138527	SUB VESTIBULE CONVERSION ⁽³⁾	(SINGLE DOOR)	DEDUCT (59.00)
138529		(PAIR DOOR)	DEDUCT (118.00)

DOOR OPTIONS (ALL PRICES ARE PER LEAF UNLESS OTHERWISE NOTED)

350-XXX	SUB 350 MEDIUM STILE DOOR (CHANGE PREFIX TO 350)	200.00
500-XXX	SUB 500 WIDE STILE DOOR (CHANGE PREFIX TO 500)	375.00
138233A1	SPECIAL HEIGHT DOOR (MAX = 8'0") ⁽⁴⁾	175.00
138234A1	SPECIAL WIDTH DOOR (MAX = 4'0") ⁽⁴⁾ (USES CP PUSH)	190.00
138214A1	SUB 1/4" SQUARE GLASS STOP	NO CHARGE
138215A1	SUB 3/8" SQUARE GLASS STOP	NO CHARGE
138216A1	SUB 1/2" SQUARE GLASS STOP	NO CHARGE
138217A1	SUB 5/8" SQUARE GLASS STOP	NO CHARGE
138218A1	SUB 3/4" SQUARE GLASS STOP	NO CHARGE
138219A1	SUB 1" SQUARE GLASS STOP	NO CHARGE
138725A1	SUB 7-1/2" BOTTOM RAIL	38.00
138727A1	SUB 10" BOTTOM RAIL	75.00
138731A1	SUB 12" BOTTOM RAIL	290.00
200795A1	ADD 3'0" DOOR BOTTOM WEATHERING (SHIP LOOSE)	25.00
200796A1	ADD 3'6" DOOR BOTTOM WEATHERING (SHIP LOOSE)	27.00
200799A1	ADD 4'0" DOOR BOTTOM WEATHERING (SHIP LOOSE)	28.00
200798A1	ADD 6'0" DOOR BOTTOM WEATHERING FOR PAIRS (SHIP LOOSE)	50.00

DOOR CROSS RAIL OPTIONS (ALL PRICES ARE PER RAIL PER LEAF)

(A MAXIMUM OF UP TO 2 HORIZONTAL RAILS PER LEAF APPLIES TO THE A1 SECTION)

038854	5/16" MUNTIN	143.00
038528	7/8" CROSS RAIL	157.00
038529	1-3/8" CROSS RAIL	160.00
038855	2-1/4" CROSS RAIL	164.00
038915	3-1/2" CROSS RAIL	174.00
038735	6" CROSS RAIL	192.00
038123	8-1/4" CROSS RAIL	199.00

¹ PRICE DOES NOT INCLUDE CLOSER. ADD CLOSER FROM SECTION A3.

² PRICE INCLUDES A.R. 4510 LATCH LOCK, A.R. 4560 LEVER HANDLE, STRIKE PLATE & (1) CYLINDER. TO SUBSTITUTE A.R. 4565 EMERGENCY THUMB TURN USE PART #138240A1 AT NO CHARGE LIST, OR TO SUB A.R. 4590 LATCH PADDLE USE PART #138241A1 AND ADD \$60.00 LIST. TO ADD A.R. 7130 ELECTRIC STRIKE HARDWARE AND FRAME PREP FOR SINGLE FRAME SUB #138238A1 AND ADD \$464.00 LIST, TO ADD A.R. 7130 ELECTRIC STRIKE HARDWARE ONLY FOR SINGLE FRAME SUB #138242A1 AND ADD \$360.00 LIST, TO ADD A.R. 7130 ELECTRIC STRIKE FRAME PREP ONLY FOR SINGLE FRAME SUB #138243A1 AND ADD \$104.00 LIST, TO ADD A.R. 7130 ELECTRIC STRIKE FOR PAIR DOORS SUB INTERMEDIATE DUTY PART #138244A1 OR CONTINUOUS DUTY PART #138396A1 AND ADD \$500.00 LIST.

³ VESTIBULE DOOR OPTION REMAINS WITH 11/16" DOOR BOTTOM CLEARANCE (PRICE INCLUDES DEDUCT FOR LOCK, CYLINDER AND THUMBTURN, FLUSHBOLTS ON PAIRS, AND THRESHOLD ON FRAMES).

⁴ REFER TO PAGE A1/3 FOR SPECIAL SIZE CHARGE RULES AND LIMITATIONS.

NOTE: THE USE OF DOUBLE BEND PUSH BARS IS SUGGESTED FOR DOORS REQUIRING 1/2" TO 1" INSULATING GLASS AND/OR DOORS WITH INTERMEDIATE CROSS RAILS. ADD APPROPRIATE PUSH/PULL OR PUSH BAR SUBSTITUTION FROM PAGE A1/32.

EC 97912-065

CENTER PIVOT (END LOAD) FRAMES

PRICE INCLUDES:

- TRIFAB® VERSAGLAZE® 450 CENTER FRAME FABRICATED FOR TOP END LOAD ARM WITH BOTTOM CENTER PIVOTS AND STANDARD LOCKING HARDWARE (FLUSH BOLTS ON PAIRS).
- FRAMES WITH TRANSOM AREA (10' 3-1/2") INCLUDE TRANSOM BAR WITH STOPS AND GASKETS.
- FRAMES INCLUDE THRESHOLD, STANDARD 4" WIDE.

NOTE: ALL CLOSERS SOLD SEPARATELY, SELECT CLOSER FROM SECTION A3.

FRAME ONLY							
SYSTEM + TYPE = PACKAGE I.E. 450-XXX + SCEMS36 = 450SCEMS36							
DOOR OPENING	SINGLE	SINGLE	SINGLE	SINGLE	PAIR	PAIR	
	3'0" x 7'0"	3'0" x 7'0"	3'6" x 7'0"	3'6" x 7'0"	6'0" x 7'0"	6'0" x 7'0"	
CENTER PIVOTS - END LOAD							
PART NO.	450-XXX	SCEMS36	SCEMS36TR	SCEMS42	SCEMS42TR	PCEMS72	PCEMS72TR
#17 GRP.		\$301.00	\$472.00	\$328.00	\$506.00	\$370.00	\$631.00
#40 GRP.		314.00	484.00	340.00	518.00	382.00	644.00
#29 GRP.		342.00	513.00	369.00	547.00	410.00	672.00

FRAME HARDWARE OPTIONS (ALL PRICES ARE EACH)		
138521	SUB CONTROLLER ON PAIRS	NO CHARGE
138523	SUB 3-PT LOCK ON PAIRS	NO CHARGE
138501	SUB MS 1850 SHORT THROW DEADBOLT	NO CHARGE
138504	SUB MS 1850 HOOK BOLT	NO CHARGE
138525	SUB ADAMS RITE 4510 LOCK ⁽¹⁾	(SINGLE FRAME) 23.00
138507	ADD ADAMS RITE 4015 TWO POINT THRESHOLD PREP	(SINGLE FRAME) 30.00
138508		(PAIR FRAME) 30.00
138528	SUB VESTIBULE CONVERSION ⁽²⁾	(SINGLE FRAME) DEDUCT (38.00)
138530		(PAIR FRAME) DEDUCT (43.00)
FRAME SYSTEM OPTIONS (CHANGE PREFIX TO CHANGE FRAME SYSTEM)		
400-XXX	SUB TRIFAB® 400 TUBE FRAME WITHOUT TRANSOM	DEDUCT (15.00)
400-XXX	SUB TRIFAB® 400 TUBE FRAME WITH TRANSOM	DEDUCT (50.00)
451-XXX	SUB TRIFAB® VG 451 TUBE FRAME WITHOUT TRANSOM	10.00
451-XXX	SUB TRIFAB® VG 451 TUBE FRAME WITH TRANSOM	15.00
540-XXX	SUB TRIFAB® 400 OPEN-BACK WITHOUT TRANSOM	DEDUCT (30.00)
540-XXX	SUB TRIFAB® 400 OPEN-BACK WITH TRANSOM	DEDUCT (80.00)
550-XXX	SUB TRIFAB® VG* 450 OPEN-BACK WITHOUT TRANSOM	DEDUCT (15.00)
550-XXX	SUB TRIFAB® VG* 450 OPEN-BACK WITH TRANSOM	DEDUCT (30.00)
551-XXX	SUB TRIFAB® VG* 451 OPEN-BACK WITHOUT TRANSOM	DEDUCT (5.00)
551-XXX	SUB TRIFAB® VG* 451 OPEN-BACK WITH TRANSOM	DEDUCT (15.00)
*TRIFAB® VERSAGLAZE® FRAMES ARE CENTER GLAZE FRAMES		
FRAME OPTIONS (ALL PRICES ARE EACH)		
138059	SPECIAL HEIGHT FRAME ⁽³⁾ (LESS THAN 6'8" OR GREATER THAN 7'0" DOOR OPENING HEIGHT WITHOUT TRANSOM; 10' 3-1/2" TRANSOM FRAME WITH DOOR OPENING HEIGHT LESS THAN 6'8" OR GREATER THAN 7'0")	115.00
138060	SPECIAL WIDTH FRAME ⁽³⁾ (SINGLE DOOR OPENING WIDTHS OTHER THAN 3'0" OR 3'6" UP TO 4'0"; PAIR DOOR OPENING WIDTHS OTHER THAN 6'0" UP TO 8'0")	115.00
138099	SPECIAL HEIGHT TRANSOM FRAME ⁽³⁾ (OVERALL TRANSOM FRAME HEIGHT GREATER THAN 10' 3-1/2" UP TO 12'0" WITH DOOR OPENING HEIGHT FROM 6'8" TO 7'0". TRANSOM HEIGHT MAY NOT EXCEED 48". FOR TRANSOM FRAME WITH DOOR OPENING HEIGHT LESS THAN 6'8" OR GREATER THAN 7'0" ADD PART NUMBER 138059 PER FRAME.)	155.00
138400	DEDUCT TRANSOM HEAD	(SINGLE) DEDUCT (35.00)
138401		(PAIR) DEDUCT (69.00)

¹ TO ADD A.R. 7130 ELECTRIC STRIKE FRAME PREP FOR SINGLE FRAME SUB #138243A1 AND ADD \$104.00 LIST, TO ADD A.R. 7130 ELECTRIC STRIKE FOR PAIR DOORS SUB INTERMEDIATE DUTY PART #138244A1 OR CONTINUOUS DUTY PART #138396A1 AND ADD \$500.00 LIST.

² VESTIBULE DOOR OPTION REMAINS WITH 11/16" DOOR BOTTOM CLEARANCE (PRICE INCLUDES DEDUCT FOR LOCK, CYLINDER AND THUMBTURN, FLUSH BOLTS ON PAIRS, AND THRESHOLD ON FRAMES).

³ REFER TO PAGE A1/3 FOR SPECIAL SIZE CHARGE RULES AND LIMITATIONS.

Laws and building and safety codes governing the design and use of Kawneer products, such as glazed entrance, window, and curtain wall products, vary widely. Kawneer does not control the selection of product configurations, operating hardware, or glazing materials, and assumes no responsibility therefor.

Kawneer reserves the right to change configuration without prior notice when deemed necessary for product improvement.
© 2014, Kawneer Company, Inc.

PRICE INCLUDES:

- 190 NARROW STILE DOOR PREPPED FOR TOP SIDE LOAD ARM AND WITH BOTTOM CENTER PIVOT AND 1/4" BEVELED GLASS STOPS (**CLOSER AND TOP ARM ARE NOT INCLUDED**).
- DOOR INCLUDES ADAMS RITE MS 1850 DEADBOLT LOCK, CYLINDER EXTERIOR, THUMBTURN INTERIOR, FLUSH BOLTS ON PAIRS.
- DOOR INCLUDES CP PUSH BARS BACK TO BACK IN STANDARD #14, #29 OR #40 FINISH.
(FOR PUSH/PULL SUBSTITUTIONS REFER TO PAGE A1/32).

NOTE: ALL CLOSERS SOLD SEPARATELY. SELECT CLOSER FROM SECTION A3.

DOOR ONLY
SYSTEM + TYPE = PACKAGE
I.E. 190-XXX + RCSMS36 = 190RCSMS36

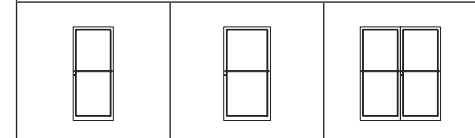

DOOR OPENING	SINGLE 3'0" x 7'0"	SINGLE 3'6" x 7'0"	PAIR 6'0" x 7'0"
CENTER PIVOTS - SIDE LOAD			
PART NO.	RCSMS36 LCSMS36	RCSMS42 LCSMS42	PCSMS72
#17 GRP.	\$510.00	\$610.00	\$1,020.00
#40 GRP.	536.00	630.00	1,072.00
#29 GRP.	598.00	698.00	1,196.00

DOOR HARDWARE OPTIONS (ALL PRICES ARE EACH)

138070	ADD AND APPLY SIDE LOAD ARM AND CLAMPING BLOCK PACKAGE ⁽¹⁾		\$73.00
138222A1	ACCESSORIES	ADD INTERIOR EXIT INDICATOR	80.00
138224A1		ADD CYLINDER GUARD	70.00
138209		SUB CYLINDER (INTERIOR)	NO CHARGE
138509	SUB DUMMY CYLINDER		NO CHARGE
138520	SUB CONTROLLER ON PAIRS		381.00
138522	SUB 3-PT LOCK ON PAIRS		225.00
138500	SUB MS 1850 SHORT THROW DEADBOLT	(SINGLE DOOR)	NO CHARGE
138502		(PAIR DOOR)	NO CHARGE
138503	SUB MS 1850 HOOK BOLT	(SINGLE DOOR)	13.00
138505		(PAIR DOOR)	13.00
135506	ADD ADAMS RITE 4015 TWO POINT LOCK BOLT		150.00
138524	SUB ADAMS RITE 4510 LOCK ⁽²⁾	(SINGLE DOOR)	275.00
138526		(PAIR DOOR)	285.00
138527	SUB VESTIBULE CONVERSION ⁽³⁾	(SINGLE DOOR)	DEDUCT (59.00)
138529		(PAIR DOOR)	DEDUCT (118.00)

DOOR OPTIONS (ALL PRICES ARE PER LEAF UNLESS OTHERWISE NOTED)

350-XXX	SUB 350 MEDIUM STILE DOOR (CHANGE PREFIX TO 350)	200.00
500-XXX	SUB 500 WIDE STILE DOOR (CHANGE PREFIX TO 500)	375.00
138233A1	SPECIAL HEIGHT DOOR (MAX = 8'0") ⁽⁴⁾	175.00
138234A1	SPECIAL WIDTH DOOR (MAX = 4'0") ⁽⁴⁾ (USES CP PUSH)	190.00
138214A1	SUB 1/4" SQUARE GLASS STOP	NO CHARGE
138215A1	SUB 3/8" SQUARE GLASS STOP	NO CHARGE
138216A1	SUB 1/2" SQUARE GLASS STOP	NO CHARGE
138217A1	SUB 5/8" SQUARE GLASS STOP	NO CHARGE
138218A1	SUB 3/4" SQUARE GLASS STOP	NO CHARGE
138219A1	SUB 1" SQUARE GLASS STOP	NO CHARGE
138725A1	SUB 7-1/2" BOTTOM RAIL	38.00
138727A1	SUB 10" BOTTOM RAIL	75.00
138731A1	SUB 12" BOTTOM RAIL	290.00
200795A1	ADD 3'0" DOOR BOTTOM WEATHERING (SHIP LOOSE)	25.00
200796A1	ADD 3'6" DOOR BOTTOM WEATHERING (SHIP LOOSE)	27.00
200799A1	ADD 4'0" DOOR BOTTOM WEATHERING (SHIP LOOSE)	28.00
200798A1	ADD 6'0" DOOR BOTTOM WEATHERING FOR PAIRS (SHIP LOOSE)	50.00

DOOR CROSS RAIL OPTIONS (ALL PRICES ARE PER RAIL PER LEAF)

(A MAXIMUM OF UP TO 2 HORIZONTAL RAILS PER LEAF APPLIES TO THE A1 SECTION)

038854	5/16" MUNTIN	143.00
038528	7/8" CROSS RAIL	157.00
038529	1-3/8" CROSS RAIL	160.00
038855	2-1/4" CROSS RAIL	164.00
038915	3-1/2" CROSS RAIL	174.00
038735	6" CROSS RAIL	192.00
038123	8-1/4" CROSS RAIL	199.00

¹ PRICE DOES NOT INCLUDE CLOSER. ADD CLOSER FROM SECTION A3.

² PRICE INCLUDES A.R. 4510 LATCH LOCK, A.R. 4560 LEVER HANDLE, STRIKE PLATE & (1) CYLINDER. TO SUBSTITUTE A.R. 4565 EMERGENCY THUMB TURN USE PART #138240A1 AT NO CHARGE LIST, OR TO SUB A.R. 4590 LATCH PADDLE USE PART #138241A1 AND ADD \$60.00 LIST. TO ADD A.R. 7130 ELECTRIC STRIKE HARDWARE AND FRAME PREP FOR SINGLE FRAME SUB #138238A1 AND ADD \$464.00 LIST, TO ADD A.R. 7130 ELECTRIC STRIKE HARDWARE ONLY FOR SINGLE FRAME SUB #138242A1 AND ADD \$360.00 LIST, TO ADD A.R. 7130 ELECTRIC STRIKE FRAME PREP ONLY FOR SINGLE FRAME SUB #138243A1 AND ADD \$104.00 LIST, TO ADD A.R. 7130 ELECTRIC STRIKE FOR PAIR DOORS SUB INTERMEDIATE DUTY PART #138244A1 OR CONTINUOUS DUTY PART #138396A1 AND ADD \$500.00 LIST.

³ VESTIBULE DOOR OPTION REMAINS WITH 11/16" DOOR BOTTOM CLEARANCE (PRICE INCLUDES DEDUCT FOR LOCK, CYLINDER AND THUMBTURN, FLUSHBOLTS ON PAIRS, AND THRESHOLD ON FRAMES).

⁴ REFER TO PAGE A1/3 FOR SPECIAL SIZE CHARGE RULES AND LIMITATIONS.

NOTE: THE USE OF DOUBLE BEND PUSH BARS IS SUGGESTED FOR DOORS REQUIRING 1/2" TO 1" INSULATING GLASS AND/OR DOORS WITH INTERMEDIATE CROSS RAILS. ADD APPROPRIATE PUSH/PULL OR PUSH BAR SUBSTITUTION FROM PAGE A1/32.

EC 97912-065

CENTER PIVOT (SIDE LOAD) FRAMES

PRICE INCLUDES:

1. TRIFAB® VERSAGLAZE® 450 CENTER FRAME FABRICATED FOR TOP SIDE LOAD ARM WITH BOTTOM CENTER PIVOTS AND STANDARD LOCKING HARDWARE (FLUSHBOLTS ON PAIRS).
2. FRAMES WITH TRANSOM AREA (10' 3-1/2") INCLUDE TRANSOM BAR WITH STOPS AND GASKETS.
3. FRAMES INCLUDE THRESHOLD, STANDARD 4" WIDE.

NOTE: ALL CLOSERS SOLD SEPARATELY, SELECT CLOSER FROM SECTION A3.

FRAME ONLY							
SYSTEM + TYPE = PACKAGE I.E. 450-XXX + SCEMS36 = 450SCEMS36							
DOOR OPENING	SINGLE	SINGLE	SINGLE	SINGLE	PAIR	PAIR	
	3'0" x 7'0"	3'0" x 7'0"	3'6" x 7'0"	3'6" x 7'0"	6'0" x 7'0"	6'0" x 7'0"	
CENTER PIVOTS - SIDE LOAD							
PART NO.	450-XXX	SCEMS36	SCEMS36TR	SCEMS42	SCEMS42TR	PCEMS72	PCEMS72TR
#17 GRP.		\$301.00	\$472.00	\$328.00	\$506.00	\$370.00	\$631.00
#40 GRP.		314.00	484.00	340.00	518.00	382.00	644.00
#29 GRP.		342.00	513.00	369.00	547.00	410.00	672.00

FRAME HARDWARE OPTIONS (ALL PRICES ARE EACH)		
138521	SUB CONTROLLER ON PAIRS	NO CHARGE
138523	SUB 3-PT LOCK ON PAIRS	NO CHARGE
138501	SUB MS 1850 SHORT THROW DEADBOLT	NO CHARGE
138504	SUB MS 1850 HOOK BOLT	NO CHARGE
138525	SUB ADAMS RITE 4510 LOCK ⁽¹⁾	(SINGLE FRAME) 23.00
138507	ADD ADAMS RITE 4015 TWO POINT THRESHOLD PREP	(SINGLE FRAME) 30.00
138508		(PAIR FRAME) 30.00
138528	SUB VESTIBULE CONVERSION ⁽²⁾	(SINGLE FRAME) DEDUCT (38.00)
138530		(PAIR FRAME) DEDUCT (43.00)

FRAME SYSTEM OPTIONS (CHANGE PREFIX TO CHANGE FRAME SYSTEM)		
400-XXX	SUB TRIFAB® 400 TUBE FRAME WITHOUT TRANSOM	DEDUCT (15.00)
400-XXX	SUB TRIFAB® 400 TUBE FRAME WITH TRANSOM	DEDUCT (50.00)
451-XXX	SUB TRIFAB® VG 451 TUBE FRAME WITHOUT TRANSOM	10.00
451-XXX	SUB TRIFAB® VG 451 TUBE FRAME WITH TRANSOM	15.00
540-XXX	SUB TRIFAB® 400 OPEN-BACK WITHOUT TRANSOM	DEDUCT (30.00)
540-XXX	SUB TRIFAB® 400 OPEN-BACK WITH TRANSOM	DEDUCT (80.00)
550-XXX	SUB TRIFAB® VG* 450 OPEN-BACK WITHOUT TRANSOM	DEDUCT (15.00)
550-XXX	SUB TRIFAB® VG* 450 OPEN-BACK WITH TRANSOM	DEDUCT (30.00)
551-XXX	SUB TRIFAB® VG* 451 OPEN-BACK WITHOUT TRANSOM	DEDUCT (5.00)
551-XXX	SUB TRIFAB® VG* 451 OPEN-BACK WITH TRANSOM	DEDUCT (15.00)

*TRIFAB® VERSAGLAZE® FRAMES ARE CENTER GLAZE FRAMES		
FRAME OPTIONS (ALL PRICES ARE EACH)		
138059	SPECIAL HEIGHT FRAME ⁽³⁾ (LESS THAN 6'8" OR GREATER THAN 7'0" DOOR OPENING HEIGHT WITHOUT TRANSOM; 10' 3-1/2" TRANSOM FRAME WITH DOOR OPENING HEIGHT LESS THAN 6'8" OR GREATER THAN 7'0")	115.00
138060	SPECIAL WIDTH FRAME ⁽³⁾ (SINGLE DOOR OPENING WIDTHS OTHER THAN 3'0" OR 3'6" UP TO 4'0"; PAIR DOOR OPENING WIDTHS OTHER THAN 6'0" UP TO 8'0")	115.00
138099	SPECIAL HEIGHT TRANSOM FRAME ⁽³⁾ (OVERALL TRANSOM FRAME HEIGHT GREATER THAN 10' 3-1/2" UP TO 12'0" WITH DOOR OPENING HEIGHT FROM 6'8" TO 7'0". TRANSOM HEIGHT MAY NOT EXCEED 48". FOR TRANSOM FRAME WITH DOOR OPENING HEIGHT LESS THAN 6'8" OR GREATER THAN 7'0" ADD PART NUMBER 138059 PER FRAME.)	155.00
138400	DEDUCT TRANSOM HEAD	(SINGLE) DEDUCT (35.00)
138401		(PAIR) DEDUCT (69.00)

¹ TO ADD A.R. 7130 ELECTRIC STRIKE HARDWARE ONLY FOR SINGLE FRAME SUB #138242A1 AND ADD \$360.00 LIST, TO ADD A.R. 7130 ELECTRIC STRIKE FRAME PREP FOR SINGLE FRAME SUB #138243A1 AND ADD \$104.00 LIST, TO ADD A.R. 7130 ELECTRIC STRIKE FOR PAIR DOORS SUB INTERMEDIATE DUTY PART #138244A1 OR CONTINUOUS DUTY PART #138396A1 AND ADD \$500.00 LIST.

² VESTIBULE DOOR OPTION REMAINS WITH 11/16" DOOR BOTTOM CLEARANCE (PRICE INCLUDES DEDUCT FOR LOCK, CYLINDER AND THUMBTURN, FLUSHBOLTS ON PAIRS, AND THRESHOLD ON FRAMES).

³ REFER TO PAGE A1/3 FOR SPECIAL SIZE CHARGE RULES AND LIMITATIONS.

Laws and building and safety codes governing the design and use of Kawneer products, such as glazed entrance, window, and curtain wall products, vary widely. Kawneer does not control the selection of product configurations, operating hardware, or glazing materials, and assumes no responsibility therefor.

Kawneer reserves the right to change configuration without prior notice when deemed necessary for product improvement.
© 2014, Kawneer Company, Inc.

Concealed Rod Exit Device Doors

EFFECTIVE
OCTOBER 28, 2022

OFFSET PIVOT DOORS

EC 97912-065

PRICE INCLUDES:

- 190 NARROW STILE DOOR WITH TOP AND BOTTOM OFFSET PIVOTS AND 1/4" BEVELED GLASS STOPS.
- DOOR INCLUDES CONCEALED ROD EXIT DEVICE, (KAWNEER 1686 EXIT DEVICE), WITH EXTERIOR CYLINDER.
- DOOR INCLUDES CO-9 PULL (FOR PUSH/PULL SUBSTITUTIONS REFER TO PAGE A1/32).
- PRICES ARE FOR 3'0" x 7'0" DOOR LEAF. FOR SPECIAL SIZE CONCEALED EXIT DEVICE USE PART 138667A1 AND ADD \$68.00 LIST PER LEAF.

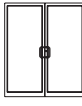
		DOOR ONLY	
		SYSTEM + TYPE = PACKAGE I.E. 190-XXX + ROPCR36 = 190ROPCR36	
			
DOOR OPENING		SINGLE	PAIR
		3'0" x 7'0"	6'0" x 7'0"
OFFSET PIVOTS			
PART NO.	190-XXX	ROPCR36 LOPCR36	POPCR72
#17 GRP.		\$869.00	\$1,738.00
#40 GRP.		905.00	1,810.00
#29 GRP.		1,012.00	2,024.00

NOTE: ALL CLOSERS SOLD SEPARATELY. SELECT CLOSER FROM SECTION A3.

DOOR HARDWARE OPTIONS (ALL PRICES ARE EACH)

138210A1	ADD KAWNEER INTERMEDIATE OFFSET PIVOT	\$175.00
138415A1	ADD RIXSON M-19 INTERMEDIATE OFFSET PIVOT	325.00
138035	OFFSET PIVOT PAINT CHARGE	140.00
138064	SUB S/A OFFSET ARM CONVERSION ⁽¹⁾ (MAXIMUM 3'6" DOOR OPENING)	160.00
138814	SUB KAWNEER 1686 WITH CYLINDER DOGGING	170.00
138830	DEDUCT FOR KAWNEER CYLINDER AND ESCUTCHEON PLATE - KAWNEER 1686	DEDUCT (38.00)
138682	SUB KAWNEER DUMMY CYLINDER	NO CHARGE
138841	ADD KAWNEER 1686 TRIM WITH LEVER HANDLE ⁽⁶⁾	(SINGLE DOOR) 175.00
138842		(PAIR DOOR) 350.00
138831	SUB FALCON 1690 EXIT DEVICE	145.00
138820	SUB FALCON 1990 EXIT DEVICE (CRASH BAR)	145.00
138822	DEDUCT CYLINDER (FALCON 1690 OR 1990)	DEDUCT (12.00)
031818	SUB ADAMS RITE 8600 CONCEALED EXIT DEVICE	NO CHARGE
031824	DEDUCT FOR KAWNEER CYLINDER AND ESCUTCHEON PLATE - 8600	DEDUCT (56.00)
138510	DEDUCT FOR NO CO-9 PULL	DEDUCT (100.00)

DOOR OPTIONS (ALL PRICES ARE PER LEAF UNLESS OTHERWISE NOTED)

350-XXX	SUB 350 MEDIUM STILE DOOR (CHANGE PREFIX TO 350)	200.00
500-XXX	SUB 500 WIDE STILE DOOR (CHANGE PREFIX TO 500)	375.00
138233A1	SPECIAL HEIGHT DOOR (MAX = 8'0") ⁽²⁾	175.00
138234A1	SPECIAL WIDTH DOOR (MAX = 4'0") ⁽²⁾ (USES CP PUSH)	190.00
138214A1	SUB 1/4" SQUARE GLASS STOP	NO CHARGE
138215A1	SUB 3/8" SQUARE GLASS STOP	NO CHARGE
138216A1	SUB 1/2" SQUARE GLASS STOP	NO CHARGE
138217A1	SUB 5/8" SQUARE GLASS STOP	NO CHARGE
138218A1	SUB 3/4" SQUARE GLASS STOP	NO CHARGE
138219A1	SUB 1" SQUARE GLASS STOP	NO CHARGE
138725A1	SUB 7-1/2" BOTTOM RAIL	38.00
138727A1	SUB 10" BOTTOM RAIL	75.00
138731A1	SUB 12" BOTTOM RAIL	290.00
200795A1	ADD 3'0" DOOR BOTTOM WEATHERING (SHIP LOOSE)	25.00
200796A1	ADD 3'6" DOOR BOTTOM WEATHERING (SHIP LOOSE)	27.00
200799A1	ADD 4'0" DOOR BOTTOM WEATHERING (SHIP LOOSE)	28.00
200798A1	ADD 6'0" DOOR BOTTOM WEATHERING FOR PAIRS (SHIP LOOSE)	50.00

DOOR CROSS RAIL OPTIONS (ALL PRICES ARE PER RAIL PER LEAF)

(A MAXIMUM OF UP TO 2 HORIZONTAL RAILS PER LEAF APPLIES TO THE A1 SECTION)

038854	5/16" MUNTIN	143.00
038528	7/8" CROSS RAIL	157.00
038529	1-3/8" CROSS RAIL	160.00
038855	2-1/4" CROSS RAIL	164.00
038915	3-1/2" CROSS RAIL	174.00
038735	6" CROSS RAIL	192.00
038123	8-1/4" CROSS RAIL	199.00

¹ PRICE DOES NOT INCLUDE CLOSER. ADD CLOSER FROM SECTION A3.

² REFER TO PAGE A1/3 FOR SPECIAL SIZE CHARGE RULES AND LIMITATIONS.

⁶ SINGLE DOOR PRICE INCLUDES (1) TRIM WITH LEVER HANDLE, DEDUCT FOR CYLINDER MOUNTING PAD, AND DEDUCT FOR CO-9 PULL. PAIR DOOR PRICE INCLUDES (2) TRIMS WITH LEVER HANDLES, (1) DUMMY CYLINDER, DEDUCT FOR CYLINDER MOUNTING PAD, AND DEDUCT FOR CO-9 PULL.

Laws and building and safety codes governing the design and use of Kawneer products, such as glazed entrance, window, and curtain wall products, vary widely. Kawneer does not control the selection of product configurations, operating hardware, or glazing materials, and assumes no responsibility therefor.

Kawneer reserves the right to change configuration without prior notice when deemed necessary for product improvement.

© 2014, Kawneer Company, Inc.

EFFECTIVE
OCTOBER 28, 2022

Concealed Rod Exit Device Frames

EC 97912-065

OFFSET PIVOT FRAMES

PRICE INCLUDES:

1. TRIFAB® VERSAGLAZE® 450 CENTER FRAME FABRICATED FOR OFFSET PIVOTS AND EXIT DEVICE HARDWARE.
2. FRAMES WITH TRANSOM AREA (10' 3-1/2") INCLUDE TRANSOM BAR WITH STOPS AND GASKETS.
3. FRAMES INCLUDE THRESHOLD, STANDARD 4" WIDE.

**NOTE: ALL CLOSERS SOLD SEPARATELY,
SELECT CLOSER FROM SECTION A3.**

FRAME ONLY				
SYSTEM + TYPE = PACKAGE I.E. 450-XXX + ROPCR36 = 450ROPCRS36				
DOOR OPENING	SINGLE	SINGLE	PAIR	PAIR
	3'0" x 7'0"	3'0" x 7'0"	6'0" x 7'0"	6'0" x 7'0"

OFFSET PIVOTS					
PART NO.	450-XXX	ROPCR36 LOPCR36	ROPCR36TR LOPCR36TR	POPCR72	POPCR72TR
#17 GRP.		\$296.00	\$463.00	\$363.00	\$620.00
#40 GRP.		308.00	475.00	375.00	632.00
#29 GRP.		336.00	503.00	403.00	660.00

FRAME HARDWARE OPTIONS (ALL PRICES ARE EACH)		
138211A1	ADD KAWNEER INTERMEDIATE OFFSET PIVOT	\$35.00
138416A1	ADD RIXSON M-19 INTERMEDIATE OFFSET PIVOT	115.00
138065	SUB STD COC S/A OFFSET ARM CONVERSION ⁽¹⁾ (MAXIMUM 3'6" DOOR OPENING)	148.00
138832	SUB FOR FALCON 1690, 1990 EXIT DEVICE (FRAME PREP)	NO CHARGE
031825	SUB ADAMS RITE 8600 EXIT DEVICE (FRAME PREP)	NO CHARGE
FRAME SYSTEM OPTIONS (CHANGE PREFIX TO CHANGE FRAME SYSTEM)		
400-XXX	SUB TRIFAB® 400 TUBE FRAME WITHOUT TRANSOM	DEDUCT (15.00)
400-XXX	SUB TRIFAB® 400 TUBE FRAME WITH TRANSOM	DEDUCT (50.00)
451-XXX	SUB TRIFAB® VG* 451 TUBE FRAME WITHOUT TRANSOM	10.00
451-XXX	SUB TRIFAB® VG* 451 TUBE FRAME WITH TRANSOM	15.00
540-XXX	SUB TRIFAB® 400 OPEN-BACK WITHOUT TRANSOM	DEDUCT (30.00)
540-XXX	SUB TRIFAB® 400 OPEN-BACK WITH TRANSOM	DEDUCT (80.00)
550-XXX	SUB TRIFAB® VG* 450 OPEN-BACK WITHOUT TRANSOM	DEDUCT (15.00)
550-XXX	SUB TRIFAB® VG* 450 OPEN-BACK WITH TRANSOM	DEDUCT (30.00)
551-XXX	SUB TRIFAB® VG* 451 OPEN-BACK WITHOUT TRANSOM	DEDUCT (5.00)
551-XXX	SUB TRIFAB® VG* 451 OPEN-BACK WITH TRANSOM	DEDUCT (15.00)

*TRIFAB® VERSAGLAZE® FRAMES ARE CENTER GLAZE FRAMES		
FRAME OPTIONS (ALL PRICES ARE EACH)		
138059	SPECIAL HEIGHT FRAME ⁽²⁾ (LESS THAN 6'8" OR GREATER THAN 7'0" DOOR OPENING HEIGHT WITHOUT TRANSOM; 10' 3-1/2" TRANSOM FRAME WITH DOOR OPENING HEIGHT LESS THAN 6'8" OR GREATER THAN 7'0")	115.00
138060	SPECIAL WIDTH FRAME ⁽²⁾ (SINGLE DOOR OPENING WIDTHS OTHER THAN 3'0" OR 3'6" UP TO 4'0"; PAIR DOOR OPENING WIDTHS OTHER THAN 6'0" UP TO 8'0")	115.00
138099	SPECIAL HEIGHT TRANSOM FRAME ⁽²⁾ (OVERALL TRANSOM FRAME HEIGHT GREATER THAN 10' 3-1/2" UP TO 12'0" WITH DOOR OPENING HEIGHT FROM 6'8" TO 7'0". TRANSOM HEIGHT MAY NOT EXCEED 48". FOR TRANSOM FRAME WITH DOOR OPENING HEIGHT LESS THAN 6'8" OR GREATER THAN 7'0" ADD PART NUMBER 138059 PER FRAME.)	155.00
138400	DEDUCT TRANSOM HEAD	(SINGLE) DEDUCT (35.00)
138401		(PAIR) DEDUCT (69.00)

¹ PRICE DOES NOT INCLUDE CLOSER. ADD CLOSER FROM SECTION A3.
² REFER TO PAGE A1/3 FOR SPECIAL SIZE CHARGE RULES AND LIMITATIONS.

Laws and building and safety codes governing the design and use of Kawneer products, such as glazed entrance, window, and curtain wall products, vary widely. Kawneer does not control the selection of product configurations, operating hardware, or glazing materials, and assumes no responsibility therefor.

Kawneer reserves the right to change configuration without prior notice when deemed necessary for product improvement.
© 2014, Kawneer Company, Inc.

Concealed Rod Exit Device Doors

EFFECTIVE
OCTOBER 28, 2022

BUTT HINGE DOORS

EC 97912-065

PRICE INCLUDES:

- 190 NARROW STILE DOOR WITH ONE PAIR STANDARD NRP BUTT HINGE AND 1/4" BEVELED GLASS STOPS.
- DOOR INCLUDES CONCEALED ROD EXIT DEVICE (KAWNEER 1686 EXIT DEVICE) WITH EXTERIOR CYLINDER.
- DOOR INCLUDES CO-9 PULL
(FOR PUSH/PULL SUBSTITUTIONS REFER TO PAGE A1/32).
- PRICES ARE FOR 3'0" x 7'0" DOOR LEAF. FOR SPECIAL SIZE CONCEALED EXIT DEVICE USE PART 138667A1 AND ADD \$68.00 LIST PER LEAF.

DOOR ONLY
SYSTEM + TYPE = PACKAGE
I.E. 190-XXX + RBHCR36 = 190RBHCR36

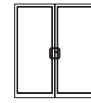

DOOR OPENING	SINGLE	PAIR
	3'0" x 7'0"	6'0" x 7'0"
BUTT HINGES		
PART NO.	RBHCR36 LBHCR36	PBHCR72
#17 GRP.	\$934.00	\$1,868.00
#40 GRP.	970.00	1,940.00
#29 GRP.	1,077.00	2,154.00

NOTE: ALL CLOSERS SOLD SEPARATELY. SELECT CLOSER FROM SECTION A3.

DOOR HARDWARE OPTIONS (ALL PRICES ARE EACH)

138409A1	ADD KAWNEER 304 STAINLESS STEEL NRP INTERMEDIATE BUTT HINGE	65.00
138064	SUB S/A OFFSET ARM CONVERSION ⁽¹⁾ (MAXIMUM 3'6" DOOR OPENING)	160.00
138814	SUB KAWNEER 1686 WITH CYLINDER DOGGING	170.00
138830	DEDUCT FOR KAWNEER CYLINDER AND ESCUTCHEON PLATE - KAWNEER 1686	DEDUCT (38.00)
138682	SUB KAWNEER DUMMY CYLINDER	NO CHARGE
138841	ADD KAWNEER 1686 TRIM WITH LEVER HANDLE ⁽⁵⁾	(SINGLE DOOR) 175.00
138842		(PAIR DOOR) 350.00
138831	SUB FALCON 1690 EXIT DEVICE	145.00
138820	SUB FALCON 1990 EXIT DEVICE (CRASH BAR)	145.00
138822	DEDUCT CYLINDER (FALCON 1690 OR 1990)	DEDUCT (12.00)
031818	SUB ADAMS RITE 8600 CONCEALED EXIT DEVICE	NO CHARGE
031824	DEDUCT FOR KAWNEER CYLINDER AND ESCUTCHEON PLATE - 8600	DEDUCT (56.00)
138510	DEDUCT FOR NO CO-9 PULL	DEDUCT (100.00)

DOOR OPTIONS (ALL PRICES ARE PER LEAF UNLESS OTHERWISE NOTED)

350-XXX	SUB 350 MEDIUM STILE DOOR (CHANGE PREFIX TO 350)	200.00
500-XXX	SUB 500 WIDE STILE DOOR (CHANGE PREFIX TO 500)	375.00
138233A1	SPECIAL HEIGHT DOOR (MAX = 8'0") ⁽²⁾	175.00
138234A1	SPECIAL WIDTH DOOR (MAX = 4'0") ⁽²⁾ (USES CP PUSH)	190.00
138214A1	SUB 1/4" SQUARE GLASS STOP	NO CHARGE
138215A1	SUB 3/8" SQUARE GLASS STOP	NO CHARGE
138216A1	SUB 1/2" SQUARE GLASS STOP	NO CHARGE
138217A1	SUB 5/8" SQUARE GLASS STOP	NO CHARGE
138218A1	SUB 3/4" SQUARE GLASS STOP	NO CHARGE
138219A1	SUB 1" SQUARE GLASS STOP	NO CHARGE
138725A1	SUB 7-1/2" BOTTOM RAIL	38.00
138727A1	SUB 10" BOTTOM RAIL	75.00
138731A1	SUB 12" BOTTOM RAIL	290.00
200795A1	ADD 3'0" DOOR BOTTOM WEATHERING (SHIP LOOSE)	25.00
200976A1	ADD 3'6" DOOR BOTTOM WEATHERING (SHIP LOOSE)	27.00
200799A1	ADD 4'0" DOOR BOTTOM WEATHERING (SHIP LOOSE)	28.00
200798A1	ADD 6'0" DOOR BOTTOM WEATHERING FOR PAIRS (SHIP LOOSE)	50.00

DOOR CROSS RAIL OPTIONS (ALL PRICES ARE PER RAIL PER LEAF)

(A MAXIMUM OF UP TO 2 HORIZONTAL RAILS PER LEAF APPLIES TO THE A1 SECTION)

038854	5/16" MUNTIN	143.00
038528	7/8" CROSS RAIL	157.00
038529	1-3/8" CROSS RAIL	160.00
038855	2-1/4" CROSS RAIL	164.00
038915	3-1/2" CROSS RAIL	174.00
038735	6" CROSS RAIL	192.00
038123	8-1/4" CROSS RAIL	199.00

¹ PRICE DOES NOT INCLUDE CLOSER. ADD CLOSER FROM SECTION A3.

² REFER TO PAGE A1/3 FOR SPECIAL SIZE CHARGE RULES AND LIMITATIONS.

⁵ SINGLE DOOR PRICE INCLUDES (1) TRIM WITH LEVER HANDLE, DEDUCT FOR CYLINDER MOUNTING PAD, AND DEDUCT FOR CO-9 PULL. PAIR DOOR PRICE INCLUDES (2) TRIMS WITH LEVER HANDLES, (1) DUMMY CYLINDER, DEDUCT FOR CYLINDER MOUNTING PAD, AND DEDUCT FOR CO-9 PULL.

Laws and building and safety codes governing the design and use of Kawneer products, such as glazed entrance, window, and curtain wall products, vary widely. Kawneer does not control the selection of product configurations, operating hardware, or glazing materials, and assumes no responsibility therefor.

Kawneer reserves the right to change configuration without prior notice when deemed necessary for product improvement.
© 2014, Kawneer Company, Inc.

EFFECTIVE
OCTOBER 28, 2022

Concealed Rod Exit Device Frames

EC 97912-065

BUTT HINGE FRAMES

PRICE INCLUDES:

1. TRIFAB® VERSAGLAZE® 450 CENTER FRAME FABRICATED FOR BUTT HINGES AND EXIT DEVICE HARDWARE.
2. FRAMES WITH TRANSOM AREA (10' 3-1/2") INCLUDE TRANSOM BAR WITH STOPS AND GASKETS.
3. FRAMES INCLUDE THRESHOLD, STANDARD 4" WIDE.

**NOTE: ALL CLOSERS SOLD SEPARATELY,
SELECT CLOSER FROM SECTION A3.**

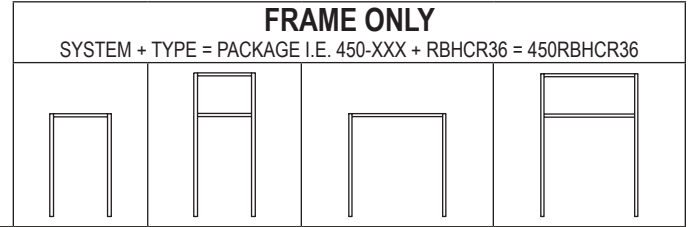

DOOR OPENING	SINGLE 3'0" x 7'0"	SINGLE 3'0" x 7'0"	PAIR 6'0" x 7'0"	PAIR 6'0" x 7'0"
BUTT HINGES				
PART NO.	RBHCR36 LBHCR36		PBHCR72	PBHCR72TR
#17 GRP.	\$323.00	\$494.00	\$414.00	\$675.00
#40 GRP.	336.00	506.00	426.00	688.00
#29 GRP.	364.00	535.00	454.00	716.00

FRAME HARDWARE OPTIONS (ALL PRICES ARE EACH)		
138418A1	ADD KAWNEER INTERMEDIATE BUTT HINGE	\$36.00
138065	SUB STD COC S/A OFFSET ARM CONVERSION ⁽¹⁾ (MAXIMUM 3'6" DOOR OPENING)	148.00
138832	SUB FOR FALCON 1690, 1990 EXIT DEVICE (FRAME PREP)	NO CHARGE
031825	SUB ADAMS RITE 8600 EXIT DEVICE (FRAME PREP)	NO CHARGE
FRAME SYSTEM OPTIONS (CHANGE PREFIX TO CHANGE FRAME SYSTEM)		
400-XXX	SUB TRIFAB® 400 TUBE FRAME WITHOUT TRANSOM	DEDUCT (15.00)
400-XXX	SUB TRIFAB® 400 TUBE FRAME WITH TRANSOM	DEDUCT (50.00)
451-XXX	SUB TRIFAB® VG 451 TUBE FRAME WITHOUT TRANSOM	10.00
451-XXX	SUB TRIFAB® VG 451 TUBE FRAME WITH TRANSOM	15.00
540-XXX	SUB TRIFAB® 400 OPEN-BACK WITHOUT TRANSOM	DEDUCT (30.00)
540-XXX	SUB TRIFAB® 400 OPEN-BACK WITH TRANSOM	DEDUCT (80.00)
550-XXX	SUB TRIFAB® VG* 450 OPEN-BACK WITHOUT TRANSOM	DEDUCT (15.00)
550-XXX	SUB TRIFAB® VG* 450 OPEN-BACK WITH TRANSOM	DEDUCT (30.00)
551-XXX	SUB TRIFAB® VG* 451 OPEN-BACK WITHOUT TRANSOM	DEDUCT (5.00)
551-XXX	SUB TRIFAB® VG* 451 OPEN-BACK WITH TRANSOM	DEDUCT (15.00)

*TRIFAB® VERSAGLAZE® FRAMES ARE CENTER GLAZE FRAMES		
FRAME OPTIONS (ALL PRICES ARE EACH)		
138059	SPECIAL HEIGHT FRAME ⁽²⁾ (LESS THAN 6'8" OR GREATER THAN 7'0" DOOR OPENING HEIGHT WITHOUT TRANSOM; 10' 3-1/2" TRANSOM FRAME WITH DOOR OPENING HEIGHT LESS THAN 6'8" OR GREATER THAN 7'0")	115.00
138060	SPECIAL WIDTH FRAME ⁽²⁾ (SINGLE DOOR OPENING WIDTHS OTHER THAN 3'0" OR 3'6" UP TO 4'0"; PAIR DOOR OPENING WIDTHS OTHER THAN 6'0" UP TO 8'0")	115.00
138099	SPECIAL HEIGHT TRANSOM FRAME ⁽²⁾ (OVERALL TRANSOM FRAME HEIGHT GREATER THAN 10' 3-1/2" UP TO 12'0" WITH DOOR OPENING HEIGHT FROM 6'8" TO 7'0". TRANSOM HEIGHT MAY NOT EXCEED 48". FOR TRANSOM FRAME WITH DOOR OPENING HEIGHT LESS THAN 6'8" OR GREATER THAN 7'0" ADD PART NUMBER 138059 PER FRAME.)	155.00
138400	DEDUCT TRANSOM HEAD	(SINGLE) DEDUCT (35.00)
138401		(PAIR) DEDUCT (69.00)

¹ PRICE DOES NOT INCLUDE CLOSER. ADD CLOSER FROM SECTION A3.
² REFER TO PAGE A1/3 FOR SPECIAL SIZE CHARGE RULES AND LIMITATIONS.

Laws and building and safety codes governing the design and use of Kawneer products, such as glazed entrance, window, and curtain wall products, vary widely. Kawneer does not control the selection of product configurations, operating hardware, or glazing materials, and assumes no responsibility therefor.

Kawneer reserves the right to change configuration without prior notice when deemed necessary for product improvement.
© 2014, Kawneer Company, Inc.

Concealed Rod Exit Device Doors

EFFECTIVE
OCTOBER 28, 2022



CONTINUOUS GEARED HINGE DOORS

EC 97912-065

PRICE INCLUDES:

- 190 NARROW STILE DOOR WITH CONTINUOUS GEARED HINGE AND 1/4" BEVELED GLASS STOPS.
- DOOR INCLUDES CONCEALED ROD EXIT DEVICE (KAWNEER 1686 EXIT DEVICE) WITH EXTERIOR CYLINDER.
- DOOR INCLUDES CO-9 PULL.
(FOR PUSH/PULL SUBSTITUTIONS REFER TO PAGE A1/32).
- PRICES ARE FOR 3'0" x 7'0" DOOR LEAF. FOR SPECIAL SIZE CONCEALED EXIT DEVICE USE PART 138667A1 AND ADD \$68.00 LIST PER LEAF.

NOTE: ALL CLOSERS SOLD SEPARATELY. SELECT CLOSER FROM SECTION A3.

DOOR ONLY		
SYSTEM + TYPE = PACKAGE I.E. 190-XXX + RCGHCR36 = 190RCGHCR36		
		
DOOR OPENING	SINGLE	PAIR
	3'0" x 7'0"	6'0" x 7'0"
CONTINUOUS GEARED HINGE		
PART NO.	190-XXX	
	RCGHCR36 LCGHCR36	PCGHCR72
#17 GRP.	\$1,182.00	\$2,356.00
#40 GRP.	1,218.00	2,436.00
#29 GRP.	1,325.00	2,650.00

DOOR HARDWARE OPTIONS (ALL PRICES ARE EACH)		
138064	SUB S/A OFFSET ARM CONVERSION ⁽¹⁾ (MAXIMUM 3'6" DOOR OPENING)	\$160.00
031818	SUB ADAMS RITE 8600 CONCEALED EXIT DEVICE	NO CHARGE
031824	DEDUCT FOR KAWNEER CYLINDER AND ESCUTCHEON PLATE - 8600	DEDUCT (56.00)
138814	SUB KAWNEER 1686 WITH CYLINDER DOGGING	170.00
138830	DEDUCT FOR KAWNEER CYLINDER AND ESCUTCHEON PLATE - KAWNEER 1686	DEDUCT (38.00)
138682	SUB KAWNEER DUMMY CYLINDER	NO CHARGE
138841	ADD KAWNEER 1686 TRIM WITH LEVER HANDLE ⁽⁶⁾	(SINGLE DOOR) 175.00
138842		(PAIR DOOR) 350.00
138831	SUB FALCON 1690 EXIT DEVICE	145.00
138820	SUB FALCON 1990 EXIT DEVICE (CRASH BAR)	145.00
138822	DEDUCT CYLINDER (FALCON 1690 OR 1990)	DEDUCT (12.00)
138510	DEDUCT FOR NO CO-9 PULL	DEDUCT (100.00)
DOOR OPTIONS (ALL PRICES ARE PER LEAF UNLESS OTHERWISE NOTED)		
350-XXX	SUB 350 MEDIUM STILE DOOR (CHANGE PREFIX TO 350)	200.00
500-XXX	SUB 500 WIDE STILE DOOR (CHANGE PREFIX TO 500)	375.00
138233A1	SPECIAL HEIGHT DOOR (MAX = 8'0") ⁽²⁾	175.00
138234A1	SPECIAL WIDTH DOOR (MAX = 4'0") ⁽²⁾ (USES CP PUSH)	190.00
138214A1	SUB 1/4" SQUARE GLASS STOP	NO CHARGE
138215A1	SUB 3/8" SQUARE GLASS STOP	NO CHARGE
138216A1	SUB 1/2" SQUARE GLASS STOP	NO CHARGE
138217A1	SUB 5/8" SQUARE GLASS STOP	NO CHARGE
138218A1	SUB 3/4" SQUARE GLASS STOP	NO CHARGE
138219A1	SUB 1" SQUARE GLASS STOP	NO CHARGE
138725A1	SUB 7-1/2" BOTTOM RAIL	38.00
138727A1	SUB 10" BOTTOM RAIL	75.00
138731A1	SUB 12" BOTTOM RAIL	290.00
200795A1	ADD 3'0" DOOR BOTTOM WEATHERING (SHIP LOOSE)	25.00
200796A1	ADD 3'6" DOOR BOTTOM WEATHERING (SHIP LOOSE)	27.00
200799A1	ADD 4'0" DOOR BOTTOM WEATHERING (SHIP LOOSE)	28.00
200798A1	ADD 6'0" DOOR BOTTOM WEATHERING FOR PAIRS (SHIP LOOSE)	50.00
DOOR CROSS RAIL OPTIONS (ALL PRICES ARE PER RAIL PER LEAF)		
(A MAXIMUM OF UP TO 2 HORIZONTAL RAILS PER LEAF APPLIES TO THE A1 SECTION)		
038854	5/16" MUNTIN	143.00
038528	7/8" CROSS RAIL	157.00
038529	1-3/8" CROSS RAIL	160.00
038855	2-1/4" CROSS RAIL	164.00
038915	3-1/2" CROSS RAIL	174.00
038735	6" CROSS RAIL	192.00
038123	8-1/4" CROSS RAIL	199.00

¹ PRICE DOES NOT INCLUDE CLOSER. ADD CLOSER FROM SECTION A3.

² REFER TO PAGE A1/3 FOR SPECIAL SIZE CHARGE RULES AND LIMITATIONS.

⁶ SINGLE DOOR PRICE INCLUDES (1) TRIM WITH LEVER HANDLE, DEDUCT FOR CYLINDER MOUNTING PAD, AND DEDUCT FOR CO-9 PULL. PAIR DOOR PRICE INCLUDES (2) TRIMS WITH LEVER HANDLES, (1) DUMMY CYLINDER, DEDUCT FOR CYLINDER MOUNTING PAD, AND DEDUCT FOR CO-9 PULL.

Laws and building and safety codes governing the design and use of Kawneer products, such as glazed entrance, window, and curtain wall products, vary widely. Kawneer does not control the selection of product configurations, operating hardware, or glazing materials, and assumes no responsibility therefor.

Kawneer reserves the right to change configuration without prior notice when deemed necessary for product improvement.
© 2014, Kawneer Company, Inc.

EFFECTIVE
OCTOBER 28, 2022

Concealed Rod Exit Device Frames

EC 97912-065

CONTINUOUS GEARED HINGE FRAMES

PRICE INCLUDES:

1. TRIFAB® VERSAGLAZE® 450 CENTER FRAME FABRICATED FOR CONTINUOUS GEARED HINGES AND EXIT DEVICE HARDWARE.
2. FRAMES WITH TRANSOM AREA (10' 3-1/2") INCLUDE TRANSOM BAR WITH STOPS AND GASKETS.
3. FRAMES INCLUDE THRESHOLD, STANDARD 4" WIDE.

**NOTE: ALL CLOSERS SOLD SEPARATELY,
SELECT CLOSER FROM SECTION A3.**

FRAME ONLY				
SYSTEM + TYPE = PACKAGE I.E. 450-XXX + RCGHCR36 = 450RCGHCR36				
DOOR OPENING	SINGLE	SINGLE	PAIR	PAIR
	3'0" x 7'0"	3'0" x 7'0"	6'0" x 7'0"	6'0" x 7'0"
CONTINUOUS GEARED HINGE				
PART NO.	RCGHCR36 LCGHCR36	RCGHCR36TR LCGHCR36TR	PCGHCR72	PCGHCR72TR
#17 GRP.	\$323.00	\$494.00	\$414.00	\$675.00
#40 GRP.	336.00	506.00	426.00	688.00
#29 GRP.	364.00	535.00	454.00	716.00

FRAME HARDWARE OPTIONS (ALL PRICES ARE EACH)

138065	SUB STD COC S/A OFFSET ARM CONVERSION ⁽¹⁾ (MAXIMUM 3'6" DOOR OPENING)	\$148.00
138832	SUB FOR FALCON 1690, 1990 EXIT DEVICE (FRAME PREP)	NO CHARGE
031825	SUB ADAMS RITE 8600 EXIT DEVICE (FRAME PREP)	NO CHARGE

FRAME SYSTEM OPTIONS (CHANGE PREFIX TO CHANGE FRAME SYSTEM)

400-XXX	SUB TRIFAB® 400 TUBE FRAME WITHOUT TRANSOM	DEDUCT (15.00)
400-XXX	SUB TRIFAB® 400 TUBE FRAME WITH TRANSOM	DEDUCT (50.00)
451-XXX	SUB TRIFAB® VG 451 TUBE FRAME WITHOUT TRANSOM	10.00
451-XXX	SUB TRIFAB® VG 451 TUBE FRAME WITH TRANSOM	15.00
540-XXX	SUB TRIFAB® 400 OPEN-BACK WITHOUT TRANSOM	DEDUCT (30.00)
540-XXX	SUB TRIFAB® 400 OPEN-BACK WITH TRANSOM	DEDUCT (80.00)
550-XXX	SUB TRIFAB® VG* 450 OPEN-BACK WITHOUT TRANSOM	DEDUCT (15.00)
550-XXX	SUB TRIFAB® VG* 450 OPEN-BACK WITH TRANSOM	DEDUCT (30.00)
551-XXX	SUB TRIFAB® VG* 451 OPEN-BACK WITHOUT TRANSOM	DEDUCT (5.00)
551-XXX	SUB TRIFAB® VG* 451 OPEN-BACK WITH TRANSOM	DEDUCT (15.00)

***TRIFAB® VERSAGLAZE® FRAMES ARE CENTER GLAZE FRAMES**

FRAME OPTIONS (ALL PRICES ARE EACH)

138059	SPECIAL HEIGHT FRAME ⁽²⁾ (LESS THAN 6'8" OR GREATER THAN 7'0" DOOR OPENING HEIGHT WITHOUT TRANSOM; 10' 3-1/2" TRANSOM FRAME WITH DOOR OPENING HEIGHT LESS THAN 6'8" OR GREATER THAN 7'0")	115.00
138060	SPECIAL WIDTH FRAME ⁽²⁾ (SINGLE DOOR OPENING WIDTHS OTHER THAN 3'0" OR 3'6" UP TO 4'0"; PAIR DOOR OPENING WIDTHS OTHER THAN 6'0" UP TO 8'0")	115.00
138099	SPECIAL HEIGHT TRANSOM FRAME ⁽²⁾ (OVERALL TRANSOM FRAME HEIGHT GREATER THAN 10' 3-1/2" UP TO 12'0" WITH DOOR OPENING HEIGHT FROM 6'8" TO 7'0". TRANSOM HEIGHT MAY NOT EXCEED 48". FOR TRANSOM FRAME WITH DOOR OPENING HEIGHT LESS THAN 6'8" OR GREATER THAN 7'0" ADD PART NUMBER 138059 PER FRAME.)	155.00
138400	DEDUCT TRANSOM HEAD	(SINGLE) DEDUCT (35.00)
138401		(PAIR) DEDUCT (69.00)

¹ PRICE DOES NOT INCLUDE CLOSER. ADD CLOSER FROM SECTION A3.

² REFER TO PAGE A1/3 FOR SPECIAL SIZE CHARGE RULES AND LIMITATIONS.

Laws and building and safety codes governing the design and use of Kawneer products, such as glazed entrance, window, and curtain wall products, vary widely. Kawneer does not control the selection of product configurations, operating hardware, or glazing materials, and assumes no responsibility therefor.

Kawneer reserves the right to change configuration without prior notice when deemed necessary for product improvement.
© 2014, Kawneer Company, Inc.

PRICE INCLUDES:

- 190 NARROW STILE DOOR WITH TOP AND BOTTOM OFFSET PIVOTS AND 1/4" BEVELED GLASS STOPS.
- DOOR INCLUDES KAWNEER PANELINE® EXIT DEVICE (3'0" ONLY) WITH EXTERIOR CYLINDER.
- DOOR INCLUDES CPN PULL.

NOTE: ALL CLOSERS SOLD SEPARATELY. SELECT CLOSER FROM SECTION A3.

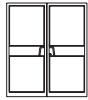
DOOR ONLY		
SYSTEM + TYPE = PACKAGE I.E. 190-XXX + ROPPNL36 = 190ROPPNL36		
		
DOOR OPENING	SINGLE	PAIR
	3'0" x 7'0"	6'0" x 7'0"
OFFSET PIVOTS		
PART NO.	190-XXX	190-XXX
	ROPPNL36 LOPPNL36	POPPNL72
#17 GRP.	\$1,400.00	\$2,800.00
#40 GRP.	1,473.00	2,946.00
#29 GRP.	1,649.00	3,298.00

DOOR HARDWARE OPTIONS (ALL PRICES ARE EACH)		
138210A1	ADD KAWNEER INTERMEDIATE OFFSET PIVOT	\$175.00
138415A1	ADD RIXSON M-19 INTERMEDIATE OFFSET PIVOT	325.00
138035	OFFSET PIVOT PAINT CHARGE	140.00
138064	SUB S/A OFFSET ARM CONVERSION ⁽¹⁾ (MAXIMUM 3'6" DOOR OPENING)	160.00
138828	ADD PANELINE® CYLINDER GUARD (FOR USE WITH CPN PULL ONLY)	64.00
138822	DEDUCT CYLINDER	DEDUCT (12.00)
138813	SUB PANELINE® EXIT DEVICE WITH CYLINDER DOGGING	150.00
138829	SUB DUMMY PANELINE® RAIL	DEDUCT (372.00)
DOOR OPTIONS (ALL PRICES ARE PER LEAF UNLESS OTHERWISE NOTED)		
350-XXX	SUB 350 MEDIUM STILE DOOR (CHANGE PREFIX TO 350)	200.00
500-XXX	SUB 500 WIDE STILE DOOR (CHANGE PREFIX TO 500)	375.00
138233A1	SPECIAL HEIGHT DOOR (MAX = 8'0") ⁽²⁾	175.00
N/A	SPECIAL WIDTH DOOR NOT AVAILABLE FOR PANELINE® UNITS	
138214A1	SUB 1/4" SQUARE GLASS STOP	NO CHARGE
138215A1	SUB 3/8" SQUARE GLASS STOP	NO CHARGE
138216A1	SUB 1/2" SQUARE GLASS STOP	NO CHARGE
138217A1	SUB 5/8" SQUARE GLASS STOP	NO CHARGE
138218A1	SUB 3/4" SQUARE GLASS STOP	NO CHARGE
138219A1	SUB 1" SQUARE GLASS STOP	NO CHARGE
138725A1	SUB 7-1/2" BOTTOM RAIL	38.00
138727A1	SUB 10" BOTTOM RAIL	75.00
138731A1	SUB 12" BOTTOM RAIL	290.00
200795A1	ADD 3'0" DOOR BOTTOM WEATHERING (SHIP LOOSE)	25.00
200798A1	ADD 6'0" DOOR BOTTOM WEATHERING FOR PAIRS (SHIP LOOSE)	50.00

Laws and building and safety codes governing the design and use of Kawneer products, such as glazed entrance, window, and curtain wall products, vary widely. Kawneer does not control the selection of product configurations, operating hardware, or glazing materials, and assumes no responsibility therefor.

Kawneer reserves the right to change configuration without prior notice when deemed necessary for product improvement.
© 2014, Kawneer Company, Inc.

¹ PRICE DOES NOT INCLUDE CLOSER. ADD CLOSER FROM SECTION A3.
² REFER TO PAGE A1/3 FOR SPECIAL SIZE CHARGE RULES AND LIMITATIONS.

EC 97912-065

OFFSET PIVOT FRAMES

PRICE INCLUDES:

1. TRIFAB® VERSAGLAZE® 450 CENTER FRAME FABRICATED FOR OFFSET PIVOTS AND EXIT DEVICE HARDWARE.
2. FRAMES WITH TRANSOM AREA (10' 3-1/2") INCLUDE TRANSOM BAR WITH STOPS AND GASKETS.
3. FRAMES INCLUDE THRESHOLD, STANDARD 4" WIDE.

**NOTE: ALL CLOSERS SOLD SEPARATELY,
SELECT CLOSER FROM SECTION A3.**

FRAME ONLY
SYSTEM + TYPE = PACKAGE I.E. 450-XXX + ROPPNL36 = 450ROPPNLS36

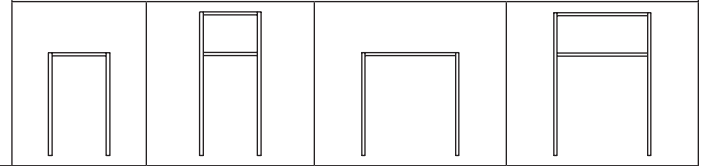

DOOR OPENING	SINGLE 3'0" x 7'0"	SINGLE 3'0" x 7'0"	PAIR 6'0" x 7'0"	PAIR 6'0" x 7'0"
OFFSET PIVOTS				
PART NO.	ROPPNL36 LOPPNL36	ROPPNL36TR LOPPNL36TR	POPPNL72	POPPNL72TR
#17 GRP.	\$296.00	\$463.00	\$363.00	\$620.00
#40 GRP.	308.00	475.00	375.00	632.00
#29 GRP.	336.00	503.00	403.00	660.00

FRAME HARDWARE OPTIONS (ALL PRICES ARE EACH)		
138211A1	ADD KAWNEER INTERMEDIATE OFFSET PIVOT	\$35.00
138416A1	ADD RIXSON M-19 INTERMEDIATE OFFSET PIVOT	115.00
138065	SUB STD COC S/A OFFSET ARM CONVERSION ⁽¹⁾ (MAXIMUM 3'6" DOOR OPENING)	148.00
FRAME SYSTEM OPTIONS (CHANGE PREFIX TO CHANGE FRAME SYSTEM)		
400-XXX	SUB TRIFAB® 400 TUBE FRAME WITHOUT TRANSOM	DEDUCT (15.00)
400-XXX	SUB TRIFAB® 400 TUBE FRAME WITH TRANSOM	DEDUCT (50.00)
451-XXX	SUB TRIFAB® VG* 451 TUBE FRAME WITHOUT TRANSOM	10.00
451-XXX	SUB TRIFAB® VG* 451 TUBE FRAME WITH TRANSOM	15.00
540-XXX	SUB TRIFAB® 400 OPEN-BACK WITHOUT TRANSOM	DEDUCT (30.00)
540-XXX	SUB TRIFAB® 400 OPEN-BACK WITH TRANSOM	DEDUCT (80.00)
550-XXX	SUB TRIFAB® VG* 450 OPEN-BACK WITHOUT TRANSOM	DEDUCT (15.00)
550-XXX	SUB TRIFAB® VG* 450 OPEN-BACK WITH TRANSOM	DEDUCT (30.00)
551-XXX	SUB TRIFAB® VG* 451 OPEN-BACK WITHOUT TRANSOM	DEDUCT (5.00)
551-XXX	SUB TRIFAB® VG* 451 OPEN-BACK WITH TRANSOM	DEDUCT (15.00)
*TRIFAB® VERSAGLAZE® FRAMES ARE CENTER GLAZE FRAMES		
FRAME OPTIONS (ALL PRICES ARE EACH)		
138059	SPECIAL HEIGHT FRAME ⁽²⁾ (LESS THAN 6'8" OR GREATER THAN 7'0" DOOR OPENING HEIGHT WITHOUT TRANSOM; 10' 3-1/2" TRANSOM FRAME WITH DOOR OPENING HEIGHT LESS THAN 6'8" OR GREATER THAN 7'0")	115.00
N/A	SPECIAL WIDTH FRAME NOT AVAILABLE FOR PANELINE UNITS	
138099	SPECIAL HEIGHT TRANSOM FRAME ⁽²⁾ (OVERALL TRANSOM FRAME HEIGHT GREATER THAN 10' 3-1/2" UP TO 12'0" WITH DOOR OPENING HEIGHT FROM 6'8" TO 7'0". TRANSOM HEIGHT MAY NOT EXCEED 48". FOR TRANSOM FRAME WITH DOOR OPENING HEIGHT LESS THAN 6'8" OR GREATER THAN 7'0" ADD PART NUMBER 138059 PER FRAME.)	155.00
138400	DEDUCT TRANSOM HEAD	(SINGLE) DEDUCT (35.00)
138401		(PAIR) DEDUCT (69.00)

¹ PRICE DOES NOT INCLUDE CLOSER. ADD CLOSER FROM SECTION A3.
² REFER TO PAGE A1/3 FOR SPECIAL SIZE CHARGE RULES AND LIMITATIONS.



Laws and building and safety codes governing the design and use of Kawneer products, such as glazed entrance, window, and curtain wall products, vary widely. Kawneer does not control the selection of product configurations, operating hardware, or glazing materials, and assumes no responsibility therefor.

Kawneer reserves the right to change configuration without prior notice when deemed necessary for product improvement.
© 2014, Kawneer Company, Inc.

PRICE INCLUDES:

- 190 NARROW STILE DOOR WITH ONE PAIR STANDARD NRP BUTT HINGE AND 1/4" BEVELED GLASS STOPS.
- DOOR INCLUDES KAWNEER PANELINE® EXIT DEVICE (3'0" ONLY) WITH EXTERIOR CYLINDER.
- DOOR INCLUDES CPN PULL.

NOTE: ALL CLOSERS SOLD SEPARATELY. SELECT CLOSER FROM SECTION A3.

DOOR ONLY	
SYSTEM + TYPE = PACKAGE I.E. 190-XXX + RBHPNL36 = 190RBHPNL36	
	

		SINGLE	PAIR
		3'0" x 7'0"	6'0" x 7'0"
BUTT HINGES			
PART NO.	190-XXX	RBHPNL36 LBHPNL36	PBHPNL72
#17 GRP.		\$1,462.00	\$2,924.00
#40 GRP.		1,538.00	3,076.00
#29 GRP.		1,720.00	3,440.00

DOOR HARDWARE OPTIONS (ALL PRICES ARE EACH)		
138409A1	ADD KAWNEER 304 STAINLESS STEEL NRP INTERMEDIATE BUTT HINGE	65.00
138064	SUB S/A OFFSET ARM CONVERSION ⁽¹⁾ (MAXIMUM 3'6" DOOR OPENING)	160.00
138830	DEDUCT FOR KAWNEER CYLINDER AND ESCUTCHEON PLATE - KAWNEER 1686	DEDUCT (38.00)
138828	ADD PANELINE® CYLINDER GUARD (FOR USE WITH CPN PULL ONLY)	64.00
138822	DEDUCT CYLINDER	DEDUCT (12.00)
138813	SUB PANELINE® EXIT DEVICE WITH CYLINDER DOGGING	150.00
138829	SUB DUMMY PANELINE® RAIL	DEDUCT (372.00)

DOOR OPTIONS (ALL PRICES ARE PER LEAF UNLESS OTHERWISE NOTED)		
350-XXX	SUB 350 MEDIUM STILE DOOR (CHANGE PREFIX TO 350)	200.00
500-XXX	SUB 500 WIDE STILE DOOR (CHANGE PREFIX TO 500)	375.00
138233A1	SPECIAL HEIGHT DOOR (MAX = 8'0") ⁽²⁾	175.00
N/A	SPECIAL WIDTH DOOR NOT AVAILABLE FOR PANELINE® UNITS	
138214A1	SUB 1/4" SQUARE GLASS STOP	NO CHARGE
138215A1	SUB 3/8" SQUARE GLASS STOP	NO CHARGE
138216A1	SUB 1/2" SQUARE GLASS STOP	NO CHARGE
138217A1	SUB 5/8" SQUARE GLASS STOP	NO CHARGE
138218A1	SUB 3/4" SQUARE GLASS STOP	NO CHARGE
138219A1	SUB 1" SQUARE GLASS STOP	NO CHARGE
138725A1	SUB 7-1/2" BOTTOM RAIL	38.00
138727A1	SUB 10" BOTTOM RAIL	75.00
138731A1	SUB 12" BOTTOM RAIL	290.00
200795A1	ADD 3'0" DOOR BOTTOM WEATHERING (SHIP LOOSE)	25.00
200798A1	ADD 6'0" DOOR BOTTOM WEATHERING FOR PAIRS (SHIP LOOSE)	50.00

Laws and building and safety codes governing the design and use of Kawneer products, such as glazed entrance, window, and curtain wall products, vary widely. Kawneer does not control the selection of product configurations, operating hardware, or glazing materials, and assumes no responsibility therefor.

Kawneer reserves the right to change configuration without prior notice when deemed necessary for product improvement.
© 2014, Kawneer Company, Inc.

¹ PRICE DOES NOT INCLUDE CLOSER. ADD CLOSER FROM SECTION A3.
² REFER TO PAGE A1/3 FOR SPECIAL SIZE CHARGE RULES AND LIMITATIONS.

EC 97912-065

BUTT HINGE FRAMES

PRICE INCLUDES:

1. TRIFAB® VERSAGLAZE® 450 CENTER FRAME FABRICATED FOR BUTT HINGES AND EXIT DEVICE HARDWARE.
2. FRAMES WITH TRANSOM AREA (10' 3-1/2") INCLUDE TRANSOM BAR WITH STOPS AND GASKETS.
3. FRAMES INCLUDE THRESHOLD, STANDARD 4" WIDE.
4. SPECIFY #17, #29, OR #40 FINISH FOR PANELINE® PUSH PAD ON PAINTED ORDERS AT TIME OF ORDERING.

**NOTE: ALL CLOSERS SOLD SEPARATELY,
SELECT CLOSER FROM SECTION A3.**

FRAME ONLY
SYSTEM + TYPE = PACKAGE I.E. 450-XXX + RBHPNL36 = 450RBHPNL36

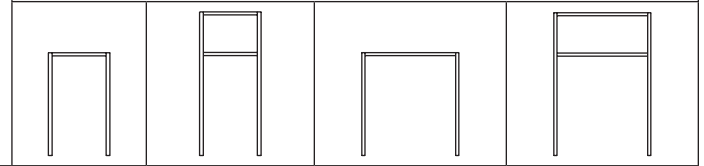

DOOR OPENING	SINGLE 3'0" x 7'0"	SINGLE 3'0" x 7'0"	PAIR 6'0" x 7'0"	PAIR 6'0" x 7'0"
BUTT HINGES				
PART NO.	RBHPNL36 LBHPNL36	RBHPNL36TR LBHPNL36TR	PBHPNL72	PBHPNL72TR
#17 GRP.	\$323.00	\$494.00	\$414.00	\$675.00
#40 GRP.	336.00	506.00	426.00	688.00
#29 GRP.	364.00	535.00	454.00	716.00

FRAME HARDWARE OPTIONS (ALL PRICES ARE EACH)		
138418A1	ADD KAWNEER INTERMEDIATE BUTT HINGE	\$36.00
138065	SUB STD COC S/A OFFSET ARM CONVERSION ⁽¹⁾ (MAXIMUM 3'6" DOOR OPENING)	148.00
FRAME SYSTEM OPTIONS (CHANGE PREFIX TO CHANGE FRAME SYSTEM)		
400-XXX	SUB TRIFAB® 400 TUBE FRAME WITHOUT TRANSOM	DEDUCT (15.00)
400-XXX	SUB TRIFAB® 400 TUBE FRAME WITH TRANSOM	DEDUCT (50.00)
451-XXX	SUB TRIFAB® VG 451 TUBE FRAME WITHOUT TRANSOM	10.00
451-XXX	SUB TRIFAB® VG 451 TUBE FRAME WITH TRANSOM	15.00
540-XXX	SUB TRIFAB® 400 OPEN-BACK WITHOUT TRANSOM	DEDUCT (30.00)
540-XXX	SUB TRIFAB® 400 OPEN-BACK WITH TRANSOM	DEDUCT (80.00)
550-XXX	SUB TRIFAB® VG* 450 OPEN-BACK WITHOUT TRANSOM	DEDUCT (15.00)
550-XXX	SUB TRIFAB® VG* 450 OPEN-BACK WITH TRANSOM	DEDUCT (30.00)
551-XXX	SUB TRIFAB® VG* 451 OPEN-BACK WITHOUT TRANSOM	DEDUCT (5.00)
551-XXX	SUB TRIFAB® VG* 451 OPEN-BACK WITH TRANSOM	DEDUCT (15.00)
*TRIFAB® VERSAGLAZE® FRAMES ARE CENTER GLAZE FRAMES		
FRAME OPTIONS (ALL PRICES ARE EACH)		
138059	SPECIAL HEIGHT FRAME ⁽²⁾ (LESS THAN 6'8" OR GREATER THAN 7'0" DOOR OPENING HEIGHT WITHOUT TRANSOM; 10' 3-1/2" TRANSOM FRAME WITH DOOR OPENING HEIGHT LESS THAN 6'8" OR GREATER THAN 7'0")	115.00
N/A	SPECIAL WIDTH FRAME NOT AVAILABLE FOR PANELINE® UNITS	
138099	SPECIAL HEIGHT TRANSOM FRAME ⁽²⁾ (OVERALL TRANSOM FRAME HEIGHT GREATER THAN 10' 3-1/2" UP TO 12'0" WITH DOOR OPENING HEIGHT FROM 6'8" TO 7'0". TRANSOM HEIGHT MAY NOT EXCEED 48". FOR TRANSOM FRAME WITH DOOR OPENING HEIGHT LESS THAN 6'8" OR GREATER THAN 7'0" ADD PART NUMBER 138059 PER FRAME.)	155.00
138400	DEDUCT TRANSOM HEAD	(SINGLE) DEDUCT (35.00)
138401		(PAIR) DEDUCT (69.00)

¹ PRICE DOES NOT INCLUDE CLOSER. ADD CLOSER FROM SECTION A3.
² REFER TO PAGE A1/3 FOR SPECIAL SIZE CHARGE RULES AND LIMITATIONS.



Laws and building and safety codes governing the design and use of Kawneer products, such as glazed entrance, window, and curtain wall products, vary widely. Kawneer does not control the selection of product configurations, operating hardware, or glazing materials, and assumes no responsibility therefor.

Kawneer reserves the right to change configuration without prior notice when deemed necessary for product improvement.
© 2014, Kawneer Company, Inc.

PRICE INCLUDES:

- 190 NARROW STILE DOOR WITH CONTINUOUS GEARED HINGE AND 1/4" BEVELED GLASS STOPS.
- DOOR INCLUDES KAWNEER PANELINE® EXIT DEVICE (3'0" ONLY) WITH EXTERIOR CYLINDER.
- DOOR INCLUDES CPN PULL.

NOTE: ALL CLOSERS SOLD SEPARATELY. SELECT CLOSER FROM SECTION A3.

		DOOR ONLY	
		SYSTEM + TYPE = PACKAGE I.E. 190-XXX + RCGHPNL36 = 190RCGHPNL36	
			
DOOR OPENING		SINGLE	PAIR
		3'0" x 7'0"	6'0" x 7'0"
CONTINUOUS GEARED HINGE			
PART NO.	190-XXX	RCGHPNL36 LCGHPNL36	PCGHPNL72
#17 GRP.		\$1,716.00	\$3,420.00
#40 GRP.		1,792.00	3,572.00
#29 GRP.		1,974.00	3,936.00

DOOR HARDWARE OPTIONS (ALL PRICES ARE EACH)		
138064	SUB S/A OFFSET ARM CONVERSION ⁽¹⁾ (MAXIMUM 3'6" DOOR OPENING)	\$160.00
138828	ADD PANELINE® CYLINDER GUARD (FOR USE WITH CPN PULL ONLY)	64.00
138822	DEDUCT CYLINDER	DEDUCT (12.00)
138813	SUB PANELINE® EXIT DEVICE WITH CYLINDER DOGGING	150.00
138829	SUB DUMMY PANELINE® RAIL	DEDUCT (372.00)
DOOR OPTIONS (ALL PRICES ARE PER LEAF UNLESS OTHERWISE NOTED)		
350-XXX	SUB 350 MEDIUM STILE DOOR (CHANGE PREFIX TO 350)	200.00
500-XXX	SUB 500 WIDE STILE DOOR (CHANGE PREFIX TO 500)	375.00
138233A1	SPECIAL HEIGHT DOOR (MAX = 8'0") ⁽²⁾	175.00
N/A	SPECIAL WIDTH DOOR NOT AVAILABLE FOR PANELINE® UNITS	
138214A1	SUB 1/4" SQUARE GLASS STOP	NO CHARGE
138215A1	SUB 3/8" SQUARE GLASS STOP	NO CHARGE
138216A1	SUB 1/2" SQUARE GLASS STOP	NO CHARGE
138217A1	SUB 5/8" SQUARE GLASS STOP	NO CHARGE
138218A1	SUB 3/4" SQUARE GLASS STOP	NO CHARGE
138219A1	SUB 1" SQUARE GLASS STOP	NO CHARGE
138725A1	SUB 7-1/2" BOTTOM RAIL	38.00
138727A1	SUB 10" BOTTOM RAIL	75.00
138731A1	SUB 12" BOTTOM RAIL	290.00
200795A1	ADD 3'0" DOOR BOTTOM WEATHERING (SHIP LOOSE)	25.00
200798A1	ADD 6'0" DOOR BOTTOM WEATHERING FOR PAIRS (SHIP LOOSE)	50.00

Laws and building and safety codes governing the design and use of Kawneer products, such as glazed entrance, window, and curtain wall products, vary widely. Kawneer does not control the selection of product configurations, operating hardware, or glazing materials, and assumes no responsibility therefor.

Kawneer reserves the right to change configuration without prior notice when deemed necessary for product improvement.
© 2014, Kawneer Company, Inc.

¹ PRICE DOES NOT INCLUDE CLOSER. ADD CLOSER FROM SECTION A3.
² REFER TO PAGE A1/3 FOR SPECIAL SIZE CHARGE RULES AND LIMITATIONS.

EC 97912-065

CONTINUOUS GEARED HINGE FRAMES

PRICE INCLUDES:

1. TRIFAB® VERSAGLAZE® 450 CENTER FRAME FABRICATED FOR CONTINUOUS GEARED HINGES AND EXIT DEVICE HARDWARE.
2. FRAMES WITH TRANSOM AREA (10' 3-1/2") INCLUDE TRANSOM BAR WITH STOPS AND GASKETS.
3. FRAMES INCLUDE THRESHOLD, STANDARD 4" WIDE.

**NOTE: ALL CLOSERS SOLD SEPARATELY,
SELECT CLOSER FROM SECTION A3.**

FRAME ONLY
SYSTEM + TYPE = PACKAGE I.E. 450-XXX + RCGHPNL36 = 450RCGHPNL36

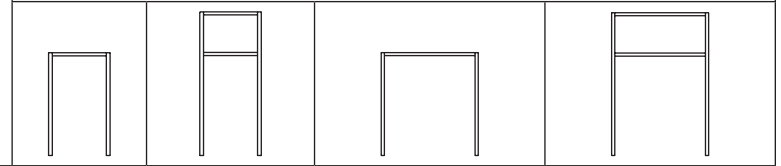

DOOR OPENING	SINGLE 3'0" x 7'0"	SINGLE 3'0" x 7'0"	PAIR 6'0" x 7'0"	PAIR 6'0" x 7'0"
CONTINUOUS GEARED HINGE				
PART NO.	RCGHPNL36 LCGHPNL36	RCGHPNL36TR LCGHPNL36TR	PCGHPNL72	PCGHPNL72TR
#17 GRP.	\$323.00	\$494.00	\$414.00	\$675.00
#40 GRP.	336.00	506.00	426.00	688.00
#29 GRP.	364.00	535.00	454.00	716.00

FRAME HARDWARE OPTIONS (ALL PRICES ARE EACH)

138065	SUB STD COC S/A OFFSET ARM CONVERSION ⁽¹⁾ (MAXIMUM 3'6" DOOR OPENING)	\$148.00
FRAME SYSTEM OPTIONS (CHANGE PREFIX TO CHANGE FRAME SYSTEM)		
400-XXX	SUB TRIFAB® 400 TUBE FRAME WITHOUT TRANSOM	DEDUCT (15.00)
400-XXX	SUB TRIFAB® 400 TUBE FRAME WITH TRANSOM	DEDUCT (50.00)
451-XXX	SUB TRIFAB® VG 451 TUBE FRAME WITHOUT TRANSOM	10.00
451-XXX	SUB TRIFAB® VG 451 TUBE FRAME WITH TRANSOM	15.00
540-XXX	SUB TRIFAB® 400 OPEN-BACK WITHOUT TRANSOM	DEDUCT (30.00)
540-XXX	SUB TRIFAB® 400 OPEN-BACK WITH TRANSOM	DEDUCT (80.00)
550-XXX	SUB TRIFAB® VG* 450 OPEN-BACK WITHOUT TRANSOM	DEDUCT (15.00)
550-XXX	SUB TRIFAB® VG* 450 OPEN-BACK WITH TRANSOM	DEDUCT (30.00)
551-XXX	SUB TRIFAB® VG* 451 OPEN-BACK WITHOUT TRANSOM	DEDUCT (5.00)
551-XXX	SUB TRIFAB® VG* 451 OPEN-BACK WITH TRANSOM	DEDUCT (15.00)

***TRIFAB® VERSAGLAZE® FRAMES ARE CENTER GLAZE FRAMES**

FRAME OPTIONS (ALL PRICES ARE EACH)

138059	SPECIAL HEIGHT FRAME ⁽²⁾ (LESS THAN 6'8" OR GREATER THAN 7'0" DOOR OPENING HEIGHT WITHOUT TRANSOM; 10' 3-1/2" TRANSOM FRAME WITH DOOR OPENING HEIGHT LESS THAN 6'8" OR GREATER THAN 7'0")	115.00
N/A	SPECIAL WIDTH FRAME NOT AVAILABLE FOR PANELINE® UNITS	
138099	SPECIAL HEIGHT TRANSOM FRAME ⁽²⁾ (OVERALL TRANSOM FRAME HEIGHT GREATER THAN 10' 3-1/2" UP TO 12'0" WITH DOOR OPENING HEIGHT FROM 6'8" TO 7'0". TRANSOM HEIGHT MAY NOT EXCEED 48". FOR TRANSOM FRAME WITH DOOR OPENING HEIGHT LESS THAN 6'8" OR GREATER THAN 7'0" ADD PART NUMBER 138059 PER FRAME.)	155.00
138400	DEDUCT TRANSOM HEAD	(SINGLE) DEDUCT (35.00)
138401		(PAIR) DEDUCT (69.00)

¹ PRICE DOES NOT INCLUDE CLOSER. ADD CLOSER FROM SECTION A3.

² REFER TO PAGE A1/3 FOR SPECIAL SIZE CHARGE RULES AND LIMITATIONS.

Laws and building and safety codes governing the design and use of Kawneer products, such as glazed entrance, window, and curtain wall products, vary widely. Kawneer does not control the selection of product configurations, operating hardware, or glazing materials, and assumes no responsibility therefor.

Kawneer reserves the right to change configuration without prior notice when deemed necessary for product improvement.
© 2014, Kawneer Company, Inc.

Rim Exit Device Doors

EFFECTIVE
OCTOBER 28, 2022

OFFSET PIVOT DOORS

EC 97912-065

PRICE INCLUDES:

- 190 NARROW STILE DOOR WITH TOP AND BOTTOM OFFSET PIVOTS AND 1/4" BEVELED GLASS STOPS.
- DOOR INCLUDES RIM EXIT DEVICE (KAWNEER 1786 EXIT DEVICE) WITH EXTERIOR CYLINDER AND RM-86 REMOVABLE MULLION ON PAIRS.
- DOOR INCLUDES CO-9 PULL.
(FOR PUSH/PULL SUBSTITUTIONS REFER TO PAGE A1/32).
- PRICES ARE FOR 3'0" x 7'0" DOOR LEAF. FOR SPECIAL SIZE RIM EXIT DEVICES USE PART 138668A1 AND ADD \$58.00 LIST PER LEAF.

NOTE: ALL CLOSERS SOLD SEPARATELY. SELECT CLOSER FROM SECTION A3.

DOOR ONLY
SYSTEM + TYPE = PACKAGE
I.E. 190-XXX + ROPRM36 = 190ROPRM36

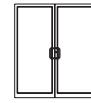

DOOR OPENING	SINGLE	PAIR
	3'0" x 7'0"	6'0" x 7'0"
OFFSET PIVOTS		
PART NO.	ROPRM36 LOPRM36	POPRM72
#17 GRP.	\$829.00	\$2,508.00
#40 GRP.	865.00	2,610.00
#29 GRP.	965.00	2,912.00

DOOR HARDWARE OPTIONS (ALL PRICES ARE EACH)

138210A1	ADD KAWNEER INTERMEDIATE OFFSET PIVOT	\$175.00
138415A1	ADD RIXSON M-19 INTERMEDIATE OFFSET PIVOT	325.00
138035	OFFSET PIVOT PAINT CHARGE	140.00
138064	SUB S/A OFFSET ARM CONVERSION ⁽¹⁾ (MAXIMUM 3'6" DOOR OPENING)	160.00
031823	SUB ADAMS RITE 8400 MORTISE EXIT DEVICE	(SINGLE DOOR) DEDUCT (23.00)
031817	SUB ADAMS RITE 8400 MORTISE EXIT DEVICE ⁽²⁾	(PAIR DOOR) DEDUCT (336.00)
031827	DEDUCT CYLINDER (ADAMS RITE 8400)	DEDUCT (12.00)
138815	SUB KAWNEER 1786 WITH CYLINDER DOGGING	170.00
138682	SUB KAWNEER DUMMY CYLINDER	NO CHARGE
138843	ADD KAWNEER 1786 TRIM WITH LEVER HANDLE ⁽³⁾	(SINGLE DOOR) 175.00
138844		(PAIR DOOR) 350.00
138833	SUB FALCON 1790 EXIT DEVICE	136.00
138821	SUB FALCON 2090 EXIT DEVICE (CRASH BAR) (SUB INCLUDES FALCON RM-70 REMOVABLE MULLION ON PAIRS)	136.00
138822	DEDUCT CYLINDER (FALCON 1790 OR 2090)	DEDUCT (12.00)
138510	DEDUCT FOR NO CO-9 PULL	DEDUCT (100.00)

DOOR OPTIONS (ALL PRICES ARE PER LEAF UNLESS OTHERWISE NOTED)

350-XXX	SUB 350 MEDIUM STILE DOOR (CHANGE PREFIX TO 350)	200.00
500-XXX	SUB 500 WIDE STILE DOOR (CHANGE PREFIX TO 500)	375.00
138233A1	SPECIAL HEIGHT DOOR (MAX = 8'0") ⁽²⁾	175.00
138234A1	SPECIAL WIDTH DOOR (MAX = 4'0") ⁽²⁾	190.00
138214A1	SUB 1/4" SQUARE GLASS STOP	NO CHARGE
138215A1	SUB 3/8" SQUARE GLASS STOP	NO CHARGE
138216A1	SUB 1/2" SQUARE GLASS STOP	NO CHARGE
138217A1	SUB 5/8" SQUARE GLASS STOP	NO CHARGE
138218A1	SUB 3/4" SQUARE GLASS STOP	NO CHARGE
138219A1	SUB 1" SQUARE GLASS STOP	NO CHARGE
138725A1	SUB 7-1/2" BOTTOM RAIL	38.00
138727A1	SUB 10" BOTTOM RAIL	75.00
138731A1	SUB 12" BOTTOM RAIL	290.00
200795A1	ADD 3'0" DOOR BOTTOM WEATHERING (SHIP LOOSE)	25.00
200796A1	ADD 3'6" DOOR BOTTOM WEATHERING (SHIP LOOSE)	27.00
200799A1	ADD 4'0" DOOR BOTTOM WEATHERING (SHIP LOOSE)	28.00
200798A1	ADD 6'0" DOOR BOTTOM WEATHERING FOR PAIRS (SHIP LOOSE)	50.00

DOOR CROSS RAIL OPTIONS (ALL PRICES ARE PER RAIL PER LEAF)

(A MAXIMUM OF UP TO 2 HORIZONTAL RAILS PER LEAF APPLIES TO THE A1 SECTION)

038854	5/16" MUNTIN	143.00
038528	7/8" CROSS RAIL	157.00
038529	1-3/8" CROSS RAIL	160.00
038855	2-1/4" CROSS RAIL	164.00
038915	3-1/2" CROSS RAIL	174.00
038735	6" CROSS RAIL	192.00
038123	8-1/4" CROSS RAIL	199.00

¹ PRICE DOES NOT INCLUDE CLOSER. ADD CLOSER FROM SECTION A3.

² REFER TO PAGE A1/3 FOR SPECIAL SIZE CHARGE RULES AND LIMITATIONS.

³ EXIT DEVICE ON ACTIVE LEAF FLUSHBOLTS ON INACTIVE LEAF.

⁵ SINGLE DOOR PRICE INCLUDES (1) TRIM WITH LEVER HANDLE, DEDUCT FOR CYLINDER MOUNTING PAD, AND DEDUCT FOR CO-9 PULL. PAIR DOOR PRICE INCLUDES (2) TRIMS WITH LEVER HANDLES, (1) DUMMY CYLINDER, DEDUCT FOR CYLINDER MOUNTING PAD, AND DEDUCT FOR CO-9 PULL.

Laws and building and safety codes governing the design and use of Kawneer products, such as glazed entrance, window, and curtain wall products, vary widely. Kawneer does not control the selection of product configurations, operating hardware, or glazing materials, and assumes no responsibility therefor.

Kawneer reserves the right to change configuration without prior notice when deemed necessary for product improvement.
© 2014, Kawneer Company, Inc.

EFFECTIVE
OCTOBER 28, 2022

Rim Exit Device Frames



EC 97912-065

OFFSET PIVOT FRAMES

PRICE INCLUDES:

1. TRIFAB® VERSAGLAZE® 450 CENTER FRAME FABRICATED FOR OFFSET PIVOTS AND EXIT DEVICE HARDWARE.
2. FRAMES WITH TRANSOM AREA (10' 3-1/2") INCLUDE TRANSOM BAR WITH STOPS AND GASKETS.
3. FRAMES INCLUDE THRESHOLD, STANDARD 4" WIDE.

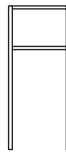
NOTE: ALL CLOSERS SOLD SEPARATELY, SELECT CLOSER FROM SECTION A3.

FRAME ONLY			
SYSTEM + TYPE = PACKAGE I.E. 450-XXX + ROPRM36 = 450ROPRMS36			
			
DOOR OPENING	SINGLE	SINGLE	PAIR
	3'0" x 7'0"	3'0" x 7'0"	6'0" x 7'0"

OFFSET PIVOTS					
PART NO.	450-XXX	ROPRM36 LOPRM36	ROPRM36TR LOPRM36TR	POPRM72	POPRM72TR
#17 GRP.		\$307.00	\$474.00	\$519.00	\$774.00
#40 GRP.		319.00	486.00	546.00	815.00
#29 GRP.		347.00	514.00	612.00	914.00

FRAME HARDWARE OPTIONS (ALL PRICES ARE EACH)		
138211A1	ADD KAWNEER INTERMEDIATE OFFSET PIVOT	\$35.00
138416A1	ADD RIXSON M-19 INTERMEDIATE OFFSET PIVOT	115.00
138065	SUB STD COC S/A OFFSET ARM CONVERSION ⁽¹⁾ (MAXIMUM 3'6" DOOR OPENING)	148.00
138834	SUB FALCON 1790 EXIT DEVICE (FRAME PREP)	NO CHARGE
138816	SUB FALCON 2090 EXIT DEVICE (FRAME PREP)	NO CHARGE
031828	SUB ADAMS RITE 8400 EXIT DEVICE (FRAME PREP)	23.00

FRAME SYSTEM OPTIONS (CHANGE PREFIX TO CHANGE FRAME SYSTEM)		
400-XXX	SUB TRIFAB® 400 TUBE FRAME WITHOUT TRANSOM	DEDUCT (15.00)
400-XXX	SUB TRIFAB® 400 TUBE FRAME WITH TRANSOM	DEDUCT (50.00)
451-XXX	SUB TRIFAB® VG* 451 TUBE FRAME WITHOUT TRANSOM	10.00
451-XXX	SUB TRIFAB® VG* 451 TUBE FRAME WITH TRANSOM	15.00
540-XXX	SUB TRIFAB® 400 OPEN-BACK WITHOUT TRANSOM	DEDUCT (30.00)
540-XXX	SUB TRIFAB® 400 OPEN-BACK WITH TRANSOM	DEDUCT (80.00)
550-XXX	SUB TRIFAB® VG* 450 OPEN-BACK WITHOUT TRANSOM	DEDUCT (15.00)
550-XXX	SUB TRIFAB® VG* 450 OPEN-BACK WITH TRANSOM	DEDUCT (30.00)
551-XXX	SUB TRIFAB® VG* 451 OPEN-BACK WITHOUT TRANSOM	DEDUCT (5.00)
551-XXX	SUB TRIFAB® VG* 451 OPEN-BACK WITH TRANSOM	DEDUCT (15.00)

***TRIFAB® VERSAGLAZE® FRAMES ARE CENTER GLAZE FRAMES**

FRAME OPTIONS (ALL PRICES ARE EACH)		
138059	SPECIAL HEIGHT FRAME ⁽²⁾ (LESS THAN 6'8" OR GREATER THAN 7'0" DOOR OPENING HEIGHT WITHOUT TRANSOM; 10' 3-1/2" TRANSOM FRAME WITH DOOR OPENING HEIGHT LESS THAN 6'8" OR GREATER THAN 7'0")	115.00
138060	SPECIAL WIDTH FRAME ⁽²⁾ (SINGLE DOOR OPENING WIDTHS OTHER THAN 3'0" OR 3'6" UP TO 4'0"; PAIR DOOR OPENING WIDTHS OTHER THAN 6'0" UP TO 8'0")	115.00
138099	SPECIAL HEIGHT TRANSOM FRAME ⁽²⁾ (OVERALL TRANSOM FRAME HEIGHT GREATER THAN 10' 3-1/2" UP TO 12'0" WITH DOOR OPENING HEIGHT FROM 6'8" TO 7'0". TRANSOM HEIGHT MAY NOT EXCEED 48". FOR TRANSOM FRAME WITH DOOR OPENING HEIGHT LESS THAN 6'8" OR GREATER THAN 7'0" ADD PART NUMBER 138059 PER FRAME.)	155.00
138400	DEDUCT TRANSOM HEAD	(SINGLE) DEDUCT (35.00)
138401		(PAIR) DEDUCT (69.00)

¹ PRICE DOES NOT INCLUDE CLOSER. ADD CLOSER FROM SECTION A3.

² REFER TO PAGE A1/3 FOR SPECIAL SIZE CHARGE RULES AND LIMITATIONS.

Laws and building and safety codes governing the design and use of Kawneer products, such as glazed entrance, window, and curtain wall products, vary widely. Kawneer does not control the selection of product configurations, operating hardware, or glazing materials, and assumes no responsibility therefor.

Kawneer reserves the right to change configuration without prior notice when deemed necessary for product improvement.
© 2014, Kawneer Company, Inc.

Rim Exit Device Doors

EFFECTIVE
OCTOBER 28, 2022

BUTT HINGE DOORS

EC 97912-065

PRICE INCLUDES:

- 190 NARROW STILE DOOR WITH ONE PAIR STANDARD NRP BUTT HINGE AND 1/4" BEVELED GLASS STOPS.
- DOOR INCLUDES RIM EXIT DEVICE (KAWNEER 1786 EXIT DEVICE) WITH EXTERIOR CYLINDER AND RM-86 REMOVABLE MULLION ON PAIRS.
- DOOR INCLUDES CO-9 PULL.
(FOR PUSH/PULL SUBSTITUTIONS REFER TO PAGE A1/32).
- PRICES ARE FOR 3'0" X 7'0" DOOR LEAF. FOR SPECIAL SIZE RIM EXIT DEVICES USE PART 138668A1 AND ADD \$58.00 LIST PER LEAF.

DOOR ONLY
SYSTEM + TYPE = PACKAGE
I.E. 190-XXX + RBHRM36 = 190RBHRM36

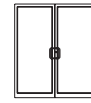

DOOR OPENING	SINGLE	PAIR
	3'0" x 7'0"	6'0" x 7'0"
BUTT HINGES		
PART NO.	RBHRM36 LBHRM36	PBHRM72
#17 GRP.	\$894.00	\$2,638.00
#40 GRP.	930.00	2,740.00
#29 GRP.	1,030.00	3,042.00

NOTE: ALL CLOSERS SOLD SEPARATELY. SELECT CLOSER FROM SECTION A3.

DOOR HARDWARE OPTIONS (ALL PRICES ARE EACH)

138409A1	ADD KAWNEER 304 STAINLESS STEEL NRP INTERMEDIATE BUTT HINGE	65.00
138064	SUB S/A OFFSET ARM CONVERSION ⁽¹⁾ (MAXIMUM 3'6" DOOR OPENING)	160.00
031823	SUB ADAMS RITE 8400 MORTISE EXIT DEVICE	(SINGLE DOOR) DEDUCT (23.00)
031817	SUB ADAMS RITE 8400 MORTISE EXIT DEVICE ⁽²⁾	(PAIR DOOR) DEDUCT (336.00)
138815	SUB KAWNEER 1786 WITH CYLINDER DOGGING	170.00
138682	SUB KAWNEER DUMMY CYLINDER	NO CHARGE
031827	DEDUCT CYLINDER (ADAMS RITE 8400)	DEDUCT (12.00)
138843	ADD KAWNEER 1786 TRIM WITH LEVER HANDLE ⁽³⁾	(SINGLE DOOR) 175.00
138844		(PAIR DOOR) 350.00
138833	SUB FALCON 1790 EXIT DEVICE	136.00
138821	SUB FALCON 2090 EXIT DEVICE (CRASH BAR) (SUB INCLUDES FALCON RM-70 REMOVABLE MULLION ON PAIRS)	136.00
138822	DEDUCT CYLINDER (FALCON 1790 OR 2090)	DEDUCT (12.00)
138510	DEDUCT FOR NO CO-9 PULL	DEDUCT (100.00)

DOOR OPTIONS (ALL PRICES ARE PER LEAF UNLESS OTHERWISE NOTED)

350-XXX	SUB 350 MEDIUM STILE DOOR (CHANGE PREFIX TO 350)	200.00
500-XXX	SUB 500 WIDE STILE DOOR (CHANGE PREFIX TO 500)	375.00
138233A1	SPECIAL HEIGHT DOOR (MAX = 8'0") ⁽²⁾	175.00
138234A1	SPECIAL WIDTH DOOR (MAX = 4'0") ⁽²⁾	190.00
138214A1	SUB 1/4" SQUARE GLASS STOP	NO CHARGE
138215A1	SUB 3/8" SQUARE GLASS STOP	NO CHARGE
138216A1	SUB 1/2" SQUARE GLASS STOP	NO CHARGE
138217A1	SUB 5/8" SQUARE GLASS STOP	NO CHARGE
138218A1	SUB 3/4" SQUARE GLASS STOP	NO CHARGE
138219A1	SUB 1" SQUARE GLASS STOP	NO CHARGE
138725A1	SUB 7-1/2" BOTTOM RAIL	38.00
138727A1	SUB 10" BOTTOM RAIL	75.00
138731A1	SUB 12" BOTTOM RAIL	290.00
200795A1	ADD 3'0" DOOR BOTTOM WEATHERING (SHIP LOOSE)	25.00
200796A1	ADD 3'6" DOOR BOTTOM WEATHERING (SHIP LOOSE)	27.00
200799A1	ADD 4'0" DOOR BOTTOM WEATHERING (SHIP LOOSE)	28.00
200798A1	ADD 6'0" DOOR BOTTOM WEATHERING FOR PAIRS (SHIP LOOSE)	50.00

DOOR CROSS RAIL OPTIONS (ALL PRICES ARE PER RAIL PER LEAF)

(A MAXIMUM OF UP TO 2 HORIZONTAL RAILS PER LEAF APPLIES TO THE A1 SECTION)

038854	5/16" MUNTIN	143.00
038528	7/8" CROSS RAIL	157.00
038529	1-3/8" CROSS RAIL	160.00
038855	2-1/4" CROSS RAIL	164.00
038915	3-1/2" CROSS RAIL	174.00
038735	6" CROSS RAIL	192.00
038123	8-1/4" CROSS RAIL	199.00

¹ PRICE DOES NOT INCLUDE CLOSER. ADD CLOSER FROM SECTION A3.

² REFER TO PAGE A1/3 FOR SPECIAL SIZE CHARGE RULES AND LIMITATIONS.

³ EXIT DEVICE ON ACTIVE LEAF FLUSHBOLTS ON INACTIVE LEAF.

⁵ SINGLE DOOR PRICE INCLUDES (1) TRIM WITH LEVER HANDLE, DEDUCT FOR CYLINDER MOUNTING PAD, AND DEDUCT FOR CO-9 PULL. PAIR DOOR PRICE INCLUDES (2) TRIMS WITH LEVER HANDLES, (1) DUMMY CYLINDER, DEDUCT FOR CYLINDER MOUNTING PAD, AND DEDUCT FOR CO-9 PULL.

Laws and building and safety codes governing the design and use of Kawneer products, such as glazed entrance, window, and curtain wall products, vary widely. Kawneer does not control the selection of product configurations, operating hardware, or glazing materials, and assumes no responsibility therefor.

Kawneer reserves the right to change configuration without prior notice when deemed necessary for product improvement.
© 2014, Kawneer Company, Inc.

EFFECTIVE
OCTOBER 28, 2022

Rim Exit Device Frames





EC 97912-065

BUTT HINGE FRAMES

PRICE INCLUDES:

1. TRIFAB® VERSAGLAZE® 450 CENTER FRAME FABRICATED FOR BUTT HINGES AND EXIT DEVICE HARDWARE.
2. FRAMES WITH TRANSOM AREA (10' 3-1/2") INCLUDE TRANSOM BAR WITH STOPS AND GASKETS.
3. FRAMES INCLUDE THRESHOLD, STANDARD 4" WIDE.

NOTE: ALL CLOSERS SOLD SEPARATELY, SELECT CLOSER FROM SECTION A3.

FRAME ONLY			
SYSTEM + TYPE = PACKAGE I.E. 450-XXX + RBHRM36 = 450RBHRM36			
			
DOOR OPENING	SINGLE	SINGLE	PAIR
	3'0" x 7'0"	3'0" x 7'0"	6'0" x 7'0"

BUTT HINGES					
PART NO.	450-XXX	RBHRM36 LBHRM36	RBHRM36TR LBHRM36TR	PBHRM72	PBHRM72TR
#17 GRP.		\$334.00	\$505.00	\$612.00	\$873.00
#40 GRP.		347.00	517.00	624.00	886.00
#29 GRP.		375.00	546.00	652.00	914.00

FRAME HARDWARE OPTIONS (ALL PRICES ARE EACH)		
138418A1	ADD KAWNEER INTERMEDIATE BUTT HINGE	\$ 36.00
138065	SUB STD COC S/A OFFSET ARM CONVERSION ⁽¹⁾ (MAXIMUM 3'6" DOOR OPENING)	148.00
138834	SUB FALCON 1790 EXIT DEVICE (FRAME PREP)	NO CHARGE
138816	SUB FALCON 2090 EXIT DEVICE (FRAME PREP)	NO CHARGE
031828	SUB ADAMS RITE 8400 EXIT DEVICE (FRAME PREP)	23.00
FRAME SYSTEM OPTIONS (CHANGE PREFIX TO CHANGE FRAME SYSTEM)		
400-XXX	SUB TRIFAB® 400 TUBE FRAME WITHOUT TRANSOM	DEDUCT (15.00)
400-XXX	SUB TRIFAB® 400 TUBE FRAME WITH TRANSOM	DEDUCT (50.00)
451-XXX	SUB TRIFAB® VG 451 TUBE FRAME WITHOUT TRANSOM	10.00
451-XXX	SUB TRIFAB® VG 451 TUBE FRAME WITH TRANSOM	15.00
540-XXX	SUB TRIFAB® 400 OPEN-BACK WITHOUT TRANSOM	DEDUCT (30.00)
540-XXX	SUB TRIFAB® 400 OPEN-BACK WITH TRANSOM	DEDUCT (80.00)
550-XXX	SUB TRIFAB® VG* 450 OPEN-BACK WITHOUT TRANSOM	DEDUCT (15.00)
550-XXX	SUB TRIFAB® VG* 450 OPEN-BACK WITH TRANSOM	DEDUCT (30.00)
551-XXX	SUB TRIFAB® VG* 451 OPEN-BACK WITHOUT TRANSOM	DEDUCT (5.00)
551-XXX	SUB TRIFAB® VG* 451 OPEN-BACK WITH TRANSOM	DEDUCT (15.00)

*TRIFAB® VERSAGLAZE® FRAMES ARE CENTER GLAZE FRAMES		
FRAME OPTIONS (ALL PRICES ARE EACH)		
138059	SPECIAL HEIGHT FRAME ⁽²⁾ (LESS THAN 6'8" OR GREATER THAN 7'0" DOOR OPENING HEIGHT WITHOUT TRANSOM; 10' 3-1/2" TRANSOM FRAME WITH DOOR OPENING HEIGHT LESS THAN 6'8" OR GREATER THAN 7'0")	115.00
138060	SPECIAL WIDTH FRAME ⁽²⁾ (SINGLE DOOR OPENING WIDTHS OTHER THAN 3'0" OR 3'6" UP TO 4'0"; PAIR DOOR OPENING WIDTHS OTHER THAN 6'0" UP TO 8'0")	115.00
138099	SPECIAL HEIGHT TRANSOM FRAME ⁽²⁾ (OVERALL TRANSOM FRAME HEIGHT GREATER THAN 10' 3-1/2" UP TO 12'0" WITH DOOR OPENING HEIGHT FROM 6'8" TO 7'0". TRANSOM HEIGHT MAY NOT EXCEED 48". FOR TRANSOM FRAME WITH DOOR OPENING HEIGHT LESS THAN 6'8" OR GREATER THAN 7'0" ADD PART NUMBER 138059 PER FRAME.)	155.00
138400	DEDUCT TRANSOM HEAD	(SINGLE) DEDUCT (35.00)
138401		(PAIR) DEDUCT (69.00)

¹ PRICE DOES NOT INCLUDE CLOSER. ADD CLOSER FROM SECTION A3.

² REFER TO PAGE A1/3 FOR SPECIAL SIZE CHARGE RULES AND LIMITATIONS.

Laws and building and safety codes governing the design and use of Kawneer products, such as glazed entrance, window, and curtain wall products, vary widely. Kawneer does not control the selection of product configurations, operating hardware, or glazing materials, and assumes no responsibility therefor.

Kawneer reserves the right to change configuration without prior notice when deemed necessary for product improvement.
© 2014, Kawneer Company, Inc.

Rim Exit Device Doors

EFFECTIVE
OCTOBER 28, 2022



CONTINUOUS GEARED HINGE DOORS

EC 97912-065

PRICE INCLUDES:

- 190 NARROW STILE DOOR WITH CONTINUOUS GEARED HINGE AND 1/4" BEVELED GLASS STOPS.
- DOOR INCLUDES RIM EXIT DEVICE (KAWNEER 1786 EXIT DEVICE) WITH EXTERIOR CYLINDER AND RM-86 REMOVABLE MULLION ON PAIRS.
- DOOR INCLUDES CO-9 PULL.
(FOR PUSH/PULL SUBSTITUTIONS REFER TO PAGE A1/32).
- PRICES ARE FOR 3'0" X 7'0" DOOR LEAF. FOR SPECIAL SIZE RIM EXIT DEVICE USE PART 138668A1 AND ADD \$58.00 LIST PER LEAF.

NOTE: ALL CLOSERS SOLD SEPARATELY. SELECT CLOSER FROM SECTION A3.

DOOR ONLY		
SYSTEM + TYPE = PACKAGE I.E. 190-XXX + RCGHRM36 = 190RCGHRM36		
		
DOOR OPENING	SINGLE	PAIR
	3'0" x 7'0"	6'0" x 7'0"
CONTINUOUS GEARED HINGE		
PART NO.	190-XXX	
	RCGHRM36	PCGHRM72
	LCGHRM36	
#17 GRP.	\$1,142.00	\$3,134.00
#40 GRP.	1,178.00	3,236.00
#29 GRP.	1,278.00	3,538.00

DOOR HARDWARE OPTIONS (ALL PRICES ARE EACH)

138064	SUB S/A OFFSET ARM CONVERSION ⁽¹⁾ (MAXIMUM 3'6" DOOR OPENING)		\$160.00
138815	SUB KAWNEER 1786 WITH CYLINDER DOGGING		170.00
138682	SUB KAWNEER DUMMY CYLINDER		NO CHARGE
138843	ADD KAWNEER 1786 TRIM WITH LEVER HANDLE ⁽⁶⁾	(SINGLE DOOR)	175.00
138844		(PAIR DOOR)	350.00
138833	SUB FALCON 1790 EXIT DEVICE		136.00
138821	SUB FALCON 2090 EXIT DEVICE (CRASH BAR) (SUB INCLUDES FALCON RM-70 REMOVABLE MULLION ON PAIRS)		136.00
138822	DEDUCT CYLINDER (FALCON 1790 OR 2090)		DEDUCT (12.00)
031823	SUB ADAMS RITE 8400 MORTISE EXIT DEVICE	(SINGLE DOOR)	DEDUCT (23.00)
031817	SUB ADAMS RITE 8400 MORTISE EXIT DEVICE ⁽⁹⁾	(PAIR DOOR)	DEDUCT (336.00)
031827	DEDUCT CYLINDER (ADAMS RITE 8400)		DEDUCT (12.00)
138510	DEDUCT FOR NO CO-9 PULL		DEDUCT (100.00)

DOOR OPTIONS (ALL PRICES ARE PER LEAF UNLESS OTHERWISE NOTED)

350-XXX	SUB 350 MEDIUM STILE DOOR (CHANGE PREFIX TO 350)	200.00
500-XXX	SUB 500 WIDE STILE DOOR (CHANGE PREFIX TO 500)	375.00
138233A1	SPECIAL HEIGHT DOOR (MAX = 8'0") ⁽²⁾	175.00
138234A1	SPECIAL WIDTH DOOR (MAX = 4'0") ⁽²⁾ (USES CP PUSH)	190.00
138214A1	SUB 1/4" SQUARE GLASS STOP	NO CHARGE
138215A1	SUB 3/8" SQUARE GLASS STOP	NO CHARGE
138216A1	SUB 1/2" SQUARE GLASS STOP	NO CHARGE
138217A1	SUB 5/8" SQUARE GLASS STOP	NO CHARGE
138218A1	SUB 3/4" SQUARE GLASS STOP	NO CHARGE
138219A1	SUB 1" SQUARE GLASS STOP	NO CHARGE
138725A1	SUB 7-1/2" BOTTOM RAIL	38.00
138727A1	SUB 10" BOTTOM RAIL	75.00
138731A1	SUB 12" BOTTOM RAIL	290.00
200795A1	ADD 3'0" DOOR BOTTOM WEATHERING (SHIP LOOSE)	25.00
200796A1	ADD 3'6" DOOR BOTTOM WEATHERING (SHIP LOOSE)	27.00
200799A1	ADD 4'0" DOOR BOTTOM WEATHERING (SHIP LOOSE)	28.00
200798A1	ADD 6'0" DOOR BOTTOM WEATHERING FOR PAIRS (SHIP LOOSE)	50.00

DOOR CROSS RAIL OPTIONS (ALL PRICES ARE PER RAIL PER LEAF)

(A MAXIMUM OF UP TO 2 HORIZONTAL RAILS PER LEAF APPLIES TO THE A1 SECTION)

038854	5/16" MUNTIN	143.00
038528	7/8" CROSS RAIL	157.00
038529	1-3/8" CROSS RAIL	160.00
038855	2-1/4" CROSS RAIL	164.00
038915	3-1/2" CROSS RAIL	174.00
038735	6" CROSS RAIL	192.00
038123	8-1/4" CROSS RAIL	199.00

¹ PRICE DOES NOT INCLUDE CLOSER. ADD CLOSER FROM SECTION A3.

² REFER TO PAGE A1/3 FOR SPECIAL SIZE CHARGE RULES AND LIMITATIONS.

³ EXIT DEVICE ON ACTIVE LEAF FLUSHBOLTS ON INACTIVE LEAF.

⁵ SINGLE DOOR PRICE INCLUDES (1) TRIM WITH LEVER HANDLE, DEDUCT FOR CYLINDER MOUNTING PAD, AND DEDUCT FOR CO-9 PULL. PAIR DOOR PRICE INCLUDES (2) TRIMS WITH LEVER HANDLES, (1) DUMMY CYLINDER, DEDUCT FOR CYLINDER MOUNTING PAD, AND DEDUCT FOR CO-9 PULL.

Law and building and safety codes governing the design and use of Kawneer products, such as glazed entrance, window, and curtain wall products, vary widely. Kawneer does not control the selection of product configurations, operating hardware, or glazing materials, and assumes no responsibility therefor.

Kawneer reserves the right to change configuration without prior notice when deemed necessary for product improvement.
© 2014, Kawneer Company, Inc.

EFFECTIVE
OCTOBER 28, 2022

Rim Exit Device Frames

EC 97912-065

CONTINUOUS GEARED HINGE FRAMES

PRICE INCLUDES:

1. TRIFAB® VERSAGLAZE® 450 CENTER FRAME FABRICATED FOR CONTINUOUS GEARED HINGES AND EXIT DEVICE HARDWARE.
2. FRAMES WITH TRANSOM AREA (10' 3-1/2") INCLUDE TRANSOM BAR WITH STOPS AND GASKETS.
3. FRAMES INCLUDE THRESHOLD, STANDARD 4" WIDE.

**NOTE: ALL CLOSERS SOLD SEPARATELY,
SELECT CLOSER FROM SECTION A3.**

FRAME ONLY				
SYSTEM + TYPE = PACKAGE I.E. 450-XXX + RCGHRM36 = 450RCGHRM36				
DOOR OPENING	SINGLE	SINGLE	PAIR	PAIR
	3'0" x 7'0"	3'0" x 7'0"	6'0" x 7'0"	6'0" x 7'0"
CONTINUOUS GEARED HINGE				
PART NO.	RCGHRM36 LCGHRM36	RCGHRM36TR LCGHRM36TR	PCGHRM72	PCGHRM72TR
#17 GRP.	\$334.00	\$505.00	\$612.00	\$873.00
#40 GRP.	347.00	517.00	624.00	886.00
#29 GRP.	375.00	546.00	652.00	914.00

FRAME HARDWARE OPTIONS (ALL PRICES ARE EACH)

138065	SUB STD COC S/A OFFSET ARM CONVERSION ⁽¹⁾ (MAXIMUM 3'6" DOOR OPENING)	\$148.00
138834	SUB FALCON 1790 EXIT DEVICE (FRAME PREP)	NO CHARGE
138816	SUB FALCON 2090 EXIT DEVICE (FRAME PREP)	NO CHARGE
031828	SUB ADAMS RITE 8400 EXIT DEVICE (FRAME PREP)	23.00

FRAME SYSTEM OPTIONS (CHANGE PREFIX TO CHANGE FRAME SYSTEM)

400-XXX	SUB TRIFAB® 400 TUBE FRAME WITHOUT TRANSOM	DEDUCT (15.00)
400-XXX	SUB TRIFAB® 400 TUBE FRAME WITH TRANSOM	DEDUCT (50.00)
451-XXX	SUB TRIFAB® VG 451 TUBE FRAME WITHOUT TRANSOM	10.00
451-XXX	SUB TRIFAB® VG 451 TUBE FRAME WITH TRANSOM	15.00
540-XXX	SUB TRIFAB® 400 OPEN-BACK WITHOUT TRANSOM	DEDUCT (30.00)
540-XXX	SUB TRIFAB® 400 OPEN-BACK WITH TRANSOM	DEDUCT (80.00)
550-XXX	SUB TRIFAB® VG* 450 OPEN-BACK WITHOUT TRANSOM	DEDUCT (15.00)
550-XXX	SUB TRIFAB® VG* 450 OPEN-BACK WITH TRANSOM	DEDUCT (30.00)
551-XXX	SUB TRIFAB® VG* 451 OPEN-BACK WITHOUT TRANSOM	DEDUCT (5.00)
551-XXX	SUB TRIFAB® VG* 451 OPEN-BACK WITH TRANSOM	DEDUCT (15.00)

***TRIFAB® VERSAGLAZE® FRAMES ARE CENTER GLAZE FRAMES**

FRAME OPTIONS (ALL PRICES ARE EACH)

138059	SPECIAL HEIGHT FRAME ⁽²⁾ (LESS THAN 6'8" OR GREATER THAN 7'0" DOOR OPENING HEIGHT WITHOUT TRANSOM; 10' 3-1/2" TRANSOM FRAME WITH DOOR OPENING HEIGHT LESS THAN 6'8" OR GREATER THAN 7'0")	115.00
138060	SPECIAL WIDTH FRAME ⁽²⁾ (SINGLE DOOR OPENING WIDTHS OTHER THAN 3'0" OR 3'6" UP TO 4'0"; PAIR DOOR OPENING WIDTHS OTHER THAN 6'0" UP TO 8'0")	115.00
138099	SPECIAL HEIGHT TRANSOM FRAME ⁽²⁾ (OVERALL TRANSOM FRAME HEIGHT GREATER THAN 10' 3-1/2" UP TO 12'0" WITH DOOR OPENING HEIGHT FROM 6'8" TO 7'0". TRANSOM HEIGHT MAY NOT EXCEED 48". FOR TRANSOM FRAME WITH DOOR OPENING HEIGHT LESS THAN 6'8" OR GREATER THAN 7'0" ADD PART NUMBER 138059 PER FRAME.)	155.00
138400	DEDUCT TRANSOM HEAD	(SINGLE) DEDUCT (35.00)
138401		(PAIR) DEDUCT (69.00)

¹ PRICE DOES NOT INCLUDE CLOSER. ADD CLOSER FROM SECTION A3.







² REFER TO PAGE A1/3 FOR SPECIAL SIZE CHARGE RULES AND LIMITATIONS.

Laws and building and safety codes governing the design and use of Kawneer products, such as glazed entrance, window, and curtain wall products, vary widely. Kawneer does not control the selection of product configurations, operating hardware, or glazing materials, and assumes no responsibility therefor.

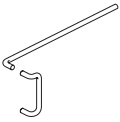
Kawneer reserves the right to change configuration without prior notice when deemed necessary for product improvement.
© 2014, Kawneer Company, Inc.

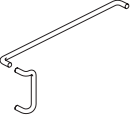
NOTES:

1. WHEN PUSH/PULL SUBSTITUTIONS ARE DESIRED SUB NUMBER AND ADD AS INDICATED (**SPECIFY FINISH AT TIME OF ORDERING**).
2. WHEN SUBSTITUTING SINGLE ACTING PUSH/PULL FOR DOUBLE ACTING, THE DOOR IS NOT FACTORY PREPPED FOR THE LOWER PULL ATTACHMENT.
3. WHEN NO PUSH PULL IS REQUIRED, USE PART 138531 AND **DEDUCT \$(71.00)** LIST PRICE PER LEAF.
4. **ALL PUSH/PULLS ARE PER LEAF.**

		PART NO.	FINISH GROUP		
			NO. 1	NO. 2	NO. 3
PUSH/PULL MODIFICATIONS					
	CO-9/CP (S/A - FINISH SUBSTITUTION ONLY) (D/A - SUB FOR CP PUSH/CP PUSH)	CO9CPSAS	---	\$184.00	\$314.00
	CO-12/CP (S/A - SUB FOR CO-9 PULL/CP PUSH) OR (D/A - SUB FOR CP PUSH/CP PUSH)	CO12CPSAS	NO CHARGE	199.00	329.00
	CP PUSH BARS (2)	CPDAS	NO CHARGE	230.00	431.00
	CO-9/CP-II (S/A - SUB FOR CO-9 PULL/CP PUSH)	CO9CP2SAS	15.00	192.00	338.00
	CO-12/CP-II	CO12CP2SAS	15.00	207.00	353.00
	CP-II Push Bars (2) (S/A - SUB FOR CO-9 PULL/CP PUSH)	CP2SAS	35.00	285.00	492.00
	CO-9/CO-9 (S/A - SUB FOR CO-9 PULL/CP PUSH) OR (D/A - SUB FOR CP PUSH/CP PUSH)	CO9BBSAS	DEDUCT (22.00)	88.00	175.00
	CO-12/CO-12 (S/A - SUB FOR CO-12 PULL/CP PUSH) OR (D/A - SUB FOR CP PUSH/CP PUSH)	CO12BBSAS	NO CHARGE	104.00	190.00
PULL MODIFICATIONS					
	CO-9 (1) (FINISH SUBSTITUTION ONLY)	CO9S	---	55.00	98.00
	CO-12 (PULL AND FINISH SUBSTITUTION ONLY)	CO12S	10.00	62.00	105.00
Color Material Identification					
Aluminum,	Clear Anodized		#14		
	Black Permanodic®		#29		
	Dark Bronze Permanodic®		#40		
Stainless Steel,	US 32			#45	
	US 32D			#46	
Bronze,	US 10B				#44

Laws and building and safety codes governing the design and use of Kawneer products, such as glazed entrance, window, and curtain wall products, vary widely. Kawneer does not control the selection of product configurations, operating hardware, or glazing materials, and assumes no responsibility therefor.

Kawneer reserves the right to change configuration without prior notice when deemed necessary for product improvement.
© 2014, Kawneer Company, Inc.